

## GENERAL DESCRIPTION

This document describes the specification for the IDTF1325 **D**igital **P**re-**D**istortion Demodulator for PA linearization. This series of devices is offered in two frequency variants to cover common UTRA bands.

## COMPETITIVE ADVANTAGE

In typical basestation transmitters digital pre-distortion is employed to improve the Transmitter performance. The signal out of the PA is sampled and the incoming Tx chain I&Q data is pre-distorted to counteract the distortion inherent in the PA. The coupled PA signal is adjusted via a digital step attenuator to the correct level and then sub-sampled at an IF frequency of ~200 MHz. This necessitates the need for a highly linear demodulator to downconvert to quadrature IF from the transmit frequency. By sampling IF\_I and IF\_Q independently and then digitally combining these signals, an effective doubling of the sample rate can be achieved. Any distortion in this path will degrade the performance of the DPD algorithm. By utilizing an ultra-linear demodulator w/integrated DSA such as the IDTF1325, the ACLR and/or power consumption of the full Tx system can be improved significantly.

- ✓ Icc: DPD function Power Consumption ↓ **40%**
- ✓ **Zero-Distortion™ Demod eliminates 2 IF amps**
- ✓ **Integrates 2 BPFs, 2 Baluns, 2 SP2Ts**
- ✓ Glitch-Free™ ATTN control



## FEATURES (I OR Q PATH)

- Wide flat performance IF BW
- Wide RF and LO BWs (~ 500 MHz)
- Ideal for Multi-Carrier Systems
- **Drives ADC directly**
- Ultra linear **+40 dBm IP3<sub>o</sub>**
- Low Noise Figure
- Excellent ACLR performance
- **100 Ω** differential output impedance
- Fully integrated DPD demodulator
- **6x6 36 pin package**
- Standby Mode w/Fast Recovery
- I<sub>CC</sub>: **262 mA**

## DEVICE BLOCK DIAGRAM

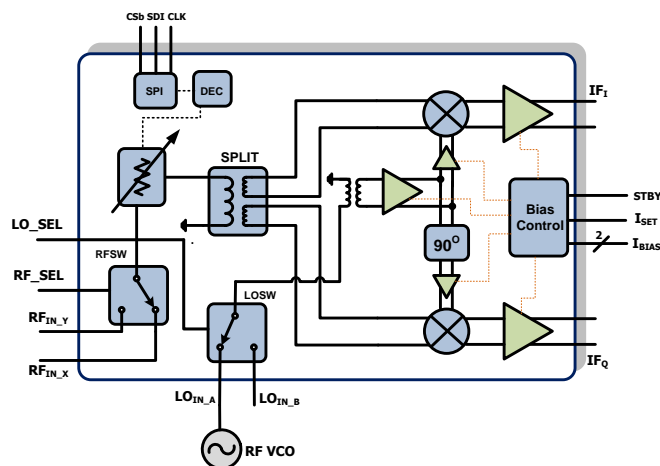

## ORDERING INFORMATION



## PART# MATRIX

Part#	RF range	UTRA bands	IF freq range	Typ. Gain	Injection
F1325	600 - 1150	5,6,8,12,13,14,17	20 - 350	8.5	High Side or Low Side
F1375	1300 - 2900	1,2,3,4,9,10,7,21, 24, 38	20 - 500	9	High Side or Low Side



**ABSOLUTE MAXIMUM RATINGS**

V <sub>CC</sub> to GND	-0.3V to +5.5V
SW_Latch, DATA, CSb, CLK, RF_SEL	0V to 3.6V
LO_SEL, STBY	0V to V <sub>CC</sub>
IF_I+, IF_I-, IF_Q+, IF_Q-	1V to (V <sub>CC</sub> + 0.3V)
LO_INA, LO_INB	-0.3V to +0.3V
RFIN_X, RFIN_Y	-0.3V to +0.3V
IF_BiasI, IF_BiasQ to GND	-0.3V to +1.2V
LO_ADJ to GND	2.1V to 4.0V
RF Input Power (Into RFIN_X or RFIN_Y)	<b>+27 dBm</b>
Continuous Power Dissipation	2.5W
θ <sub>JA</sub> (Junction – Ambient)	+40°C/W
θ <sub>JC</sub> (Junction – Case) The Case is defined as the exposed paddle	+3°C/W
Operating Temperature Range (Case Temperature)	T <sub>C</sub> = -40°C to +105°C
Maximum Junction Temperature	150°C
Storage Temperature Range	-65°C to +150°C
Moisture Sensitivity Level	<b>1</b>
Lead Temperature (soldering, 10s)	+260°C

*Stresses above those listed above may cause permanent damage to the device. Functional operation of the device at these or any other conditions above those indicated in the operational section of this specification is not implied. Exposure to absolute maximum rating conditions for extended periods may affect device reliability.*



# IDTF1325NBGI Datasheet

DPD Demodulator for PA Linearization

600MHz to 1150MHz

## IDTF1325 SPECIFICATION

Refer to Typical Application Circuit when operated with  $V_{CC} = +5.0V$ ,  $T_{CASE} = 25C$ ,  $F_{RF} = 860 \text{ MHz}$ ,  $F_{LO} = 1060 \text{ MHz}$ , Gain =  $G_{MAX}$ ,  $P_{LO} = 0 \text{ dBm}$ ,  $T_C = +25^\circ C$ ,  $STBY = GND$ , unless otherwise noted. Full Lineup measured through to I or Q path. IF Transformers and RF trace losses de-embedded.

Parameter	Comment	Symbol	min	typ	max	units
Logic Input High	For STBY, DATA, CSb, CLK, SB_Latch	$V_{IH}$	1.1			V
Logic Input Low	For STBY, DATA, CSb, CLK, SB_Latch	$V_{IL}$			0.5	V
Logic Current	$V_H = 2.3V$ , $V_L = 0V$	$I_{IH}, I_{IL}$	-115		+10	$\mu A$
Supply Voltage(s)	All $V_{CC}$ (operating range)	$V_{CC}$		4.75 to 5.25		V
Temperature Range	Operating Range	$T_{CASE}$	-40		+105	$^\circ C$
Supply Current	Total $V_{CC}$	$I_{SUPP}$		262	300 <sup>1</sup>	mA
Supply Current	Standby Mode: $STBY > V_{IH}$	$I_{STBY}$		23	30	mA
RF Freq Range	Sets LO freq range	$F_{RF}$	700		1060	MHz
IF center Freq Range	Sets LO freq range	$F_{IF}$	100		250	MHz
Oversample RF Range	<ul style="list-style-type: none"> <li>Measure Gain at I&amp;Q</li> <li>Gain setting = <math>G_{MAX}</math></li> <li><math>F_{LO} = 950 \text{ MHz}, 1080 \text{ MHz}</math></li> <li>Gain Delta &lt; 2.5 dB</li> </ul>	$F_{RFD}$	600		1150	MHz
Oversample IF Range	<ul style="list-style-type: none"> <li>Measure Gain at I&amp;Q</li> <li>Gain setting = <math>G_{MAX}</math></li> <li><math>F_{LO} = 950 \text{ MHz}, 1080 \text{ MHz}</math></li> <li>Gain Delta &lt; 2.5 dB</li> </ul>	$F_{IFD}$	20		350	MHz
IF Linearity BW	<ul style="list-style-type: none"> <li>RF Freq = 860 MHz</li> <li>OIP3 &gt; +38 dBm</li> <li><math>P_{IN} = -8 \text{ dBm}</math> per tone</li> <li>Gain setting = <math>G_{MAX}</math></li> </ul>	$IF_{LIN}$	100		300	MHz
RF Linearity BW	<ul style="list-style-type: none"> <li>IF Freq = 200 MHz</li> <li>OIP3 &gt; +35 dBm</li> <li><math>P_{IN} = -8 \text{ dBm}</math> per tone</li> <li>Gain setting = <math>G_{MAX}</math></li> </ul>	$RF_{LIN}$	700		1100	MHz
LO Freq Range	Operating Range	$F_{LOH}$	650		1200	MHz
LO Power		$P_{LO}$	-3	0	+3	dBm
RF Return Loss	Single Ended - 50 $\Omega$	$Z_{RF}$	15			dB
IF Return Loss	Differential - 100 $\Omega$	$Z_{IF}$	15			dB
LO Return Los	Single Ended (- 50 $\Omega$ )	$Z_{LO}$	12			dB
Gain maximum	<ul style="list-style-type: none"> <li>From RF_INX to I+,- &amp; Q+,-</li> <li>Gain setting = <math>G_{MAX}</math></li> <li>Pin = -8 dBm</li> </ul>	$G_{MAX}$	7	8.5	10	dB
Gain minimum	<ul style="list-style-type: none"> <li>From RF_INX to I+,-</li> <li>Gain setting = <math>G_{MIN}</math></li> <li>Pin = +14 dBm</li> </ul>	$G_{MIN}$	-19	-17.2	-16	dB



### IDTF1325 SPECIFICATION – CONTINUED

Refer to Typical Application Circuit when operated with  $V_{CC} = +5.0V$ ,  $T_{CASE} = 25C$ ,  $F_{RF} = 860\text{ MHz}$ ,  $F_{LO} = 1060\text{ MHz}$ , Gain =  $G_{MAX}$ ,  $P_{LO} = 0\text{ dBm}$ ,  $T_C = +25^\circ C$ , STBY = GND, unless otherwise noted. Full Lineup measured through to I or Q path. IF Transformers and RF trace losses de-embedded.

Parameter	Comment	Symbol	min	typ	max	units
Noise Figure	<ul style="list-style-type: none"> <li>From RF_INX to I+,I- out</li> <li>Gain setting = <math>G_{MAX}</math></li> </ul>	NF		17.7		dB
Output IP3 – $G_{MAX}$	<ul style="list-style-type: none"> <li>Measured at I+,I- and Q+,Q-</li> <li><math>P_{IN} = -8\text{ dBm}</math> per tone</li> <li>5 MHz Tone Separation</li> <li>Gain setting = <math>G_{MAX}</math></li> </ul>	OIP3 <sub>MAX</sub>	37	40		dBm
Output IP3 – $G_{-15}$	<ul style="list-style-type: none"> <li>Measured at I+,I- and Q+,Q-</li> <li><math>P_{IN} = +7\text{ dBm}</math> per tone</li> <li>5 MHz Tone Separation</li> <li>Gain setting = <math>G_{-15}</math></li> </ul>	OIP3 <sub>-15</sub>		40		dBm
2 <sup>nd</sup> Harmonic	<ul style="list-style-type: none"> <li>Measured at I+,I- and Q+,Q-</li> <li><math>P_{IN} = -8\text{ dBm}</math> per tone</li> <li>Gain setting = <math>G_{MAX}</math></li> </ul>	H2	-61 <sup>2</sup>	-66		dBc
Output IP2	<ul style="list-style-type: none"> <li>Measured at I+,I- and Q+,Q-</li> <li><math>P_{IN} = -8\text{ dBm}</math> per tone</li> <li>5 MHz Tone Separation</li> <li>Gain setting = <math>G_{MAX}</math></li> </ul>	OIP2	55	60		dBm
Output compression	<ul style="list-style-type: none"> <li>Measured at I+,I- and Q+,Q-</li> <li><math>P_{IN} = +6\text{ dBm}</math></li> <li>Gain setting = <math>G_{MAX}</math></li> </ul>	C		0.2	1	dB
Gain Ripple1	<ul style="list-style-type: none"> <li>Fixed LO = 1020 MHz</li> <li>RF = 650 to 1000 MHz</li> <li>IF = 20 to 370 MHz</li> </ul>	Ripple1		0.8	0.9	dB
Gain Ripple2	<ul style="list-style-type: none"> <li>Fixed LO = 1061.5 MHz</li> <li>RF = 591.5MHz to 1041.5MHz</li> <li>IF = 20 to 470 MHz</li> </ul>	Ripple2		1.2	1.4	dB
Group Delay Distortion	<ul style="list-style-type: none"> <li>Fixed LO = 1020 MHz</li> <li>RF = 650 to 1000 MHz</li> <li>IF = 20 to 350 MHz</li> </ul>	GDD		2		nsec
Quadrature Amplitude Balance	<ul style="list-style-type: none"> <li>From RF_INX to I+,I- &amp; Q+,Q-</li> <li>Gain setting = <math>G_{MAX}</math></li> <li>Pin = -8dBm</li> </ul>	BAL <sub>G</sub>		0	0.15	dB
Quadrature Phase Balance	<ul style="list-style-type: none"> <li></li> </ul>	BAL <sub>φ</sub>	-2.5		+1	degrees
Amplitude Balance over environmentals	<ul style="list-style-type: none"> <li><math>T_C = -40C</math> to <math>105C</math></li> <li>LO drive = -3 dBm to +3 dBm</li> </ul>	BAL <sub>GΔ</sub>	-0.2		+0.2	dB
Quadrature Phase Balance over environmentals	<ul style="list-style-type: none"> <li><math>T_C = -40C</math> to <math>105C</math></li> <li>LO drive = -3 dBm to +3 dBm</li> </ul>	BAL <sub>φΔ</sub>	-2.5		+1	degrees
LO to IF leakage		ISO <sub>LI</sub>		-40	-35	dBm
LO to RF leakage		ISO <sub>LR</sub>		-49		dBm
RF to IF isolation	Referenced to IF output power	ISO <sub>RI</sub>		-40	-35	dBc
Attenuator Range		Range		25.5		dB



**IDTF1325 SPECIFICATION – CONTINUED**

Refer to Typical Application Circuit when operated with  $V_{CC} = +5.0V$ ,  $T_{CASE} = 25C$ ,  $F_{RF} = 860\text{ MHz}$ ,  $F_{LO} = 1060\text{ MHz}$ , Gain =  $G_{MAX}$ ,  $P_{LO} = 0\text{ dBm}$ ,  $T_C = +25^\circ C$ , STBY = GND, unless otherwise noted. Full Lineup measured through to I or Q path. IF Transformers and RF trace losses de-embedded.

Parameter	Comment	Symbol	min	typ	max	units
Attenuator Glitching	<ul style="list-style-type: none"> <li>▪ Step from 15.5 to 16 dB</li> <li>▪ Step from 16 to 15.5 dB</li> <li>▪ Measure maximum excursion</li> </ul>	ATTN <sub>G</sub>		0.7		dB
Attenuator Step Accuracy		DNL		0.02	0.2	dB
Attenuator Abs. Accuracy		INL		<b>0.1</b>	<b>0.5</b>	dB
Attenuator Resolution		LSB		0.5		dB
Serial Clock Speed	SPI 3 wire bus	F <sub>CLOCK</sub>		<b>20</b>	<b>50</b>	MHz
Data to Clock Setup	SPI 3 wire bus	T <sub>S</sub>	3			nsec
Data to Clock Hold	SPI 3 wire bus	T <sub>H</sub>	3			nsec
Clock to CS Setup	SPI 3 wire bus	T <sub>EN</sub>	3			nsec
Clock Pulse Width	SPI 3 wire bus	T <sub>W</sub>	5			nsec
LO Switch Isolation		ISO <sub>LOSW</sub>		-42	-40	dBc
RF Switch Isolation		ISO <sub>RFSW</sub>		-50	-42	dBc

**RF Switch and attenuator settling times<sup>3</sup>**

EN bit on	<ul style="list-style-type: none"> <li>• LO_INA: 1060MHz, 0dBm</li> <li>• RF_INX: 860MHz, -8dBm</li> </ul>	EN <sub>ON</sub>		100		nsec	
EN bit off		EN <sub>OFF</sub>		50			
RF switched X to Y (no Y signal)		RF <sub>SWXY</sub>		300			
RF switched Y to X (no Y signal)		RF <sub>SWYX</sub>		300			
Attenuator switched 0dB to 25.5dB (max)		ATT <sub>SETL</sub>			300		
Attenuator switched 25.5dB (max) to 0dB					300		
Attenuator switched 15.5dB to 16dB					300		
Attenuator switched 16dB to 15.5dB					300		

**SPECIFICATION NOTES:**

- 1 – Items in min/max columns in **bold italics** are Guaranteed by Test
- 2 – All other Items in min/max columns are Guaranteed by Design Characterization
- 3 – Excludes SPI write time. Define Switching Time: The time from 50% CSb to 10%/90% settled to within 0.1dB of final value. Define Settling Time: The time from 50% CSb to 0.1dB of final value.

### POWER-ON SEQUENCE

The power-on sequence ensures F1325 works in default mode once powered on. If the F1325 is programmed after applying DC power, the following power-on sequence is not needed. Note: To use power on sequence, SW\_LATCH cannot be grounded permanently.

The power-on sequence should be:

1. CSb & SW\_LATCH must be set low at power-on
2. Once powered on, first set SW\_LATCH high, then set CSb high
3. Proceed with normal programming.

The default state after using power-on sequence:

- Maximum attenuationRan
- Normal operation (not Standby Mode)

### SERIAL PROGRAMMING

The device is programmed via the serial port by asserting Chip Select (CSb). Note: Most-Significant-Bit first, where the Address Word is the Most-Significant-Byte.

#### Serial mode timing diagram high level:

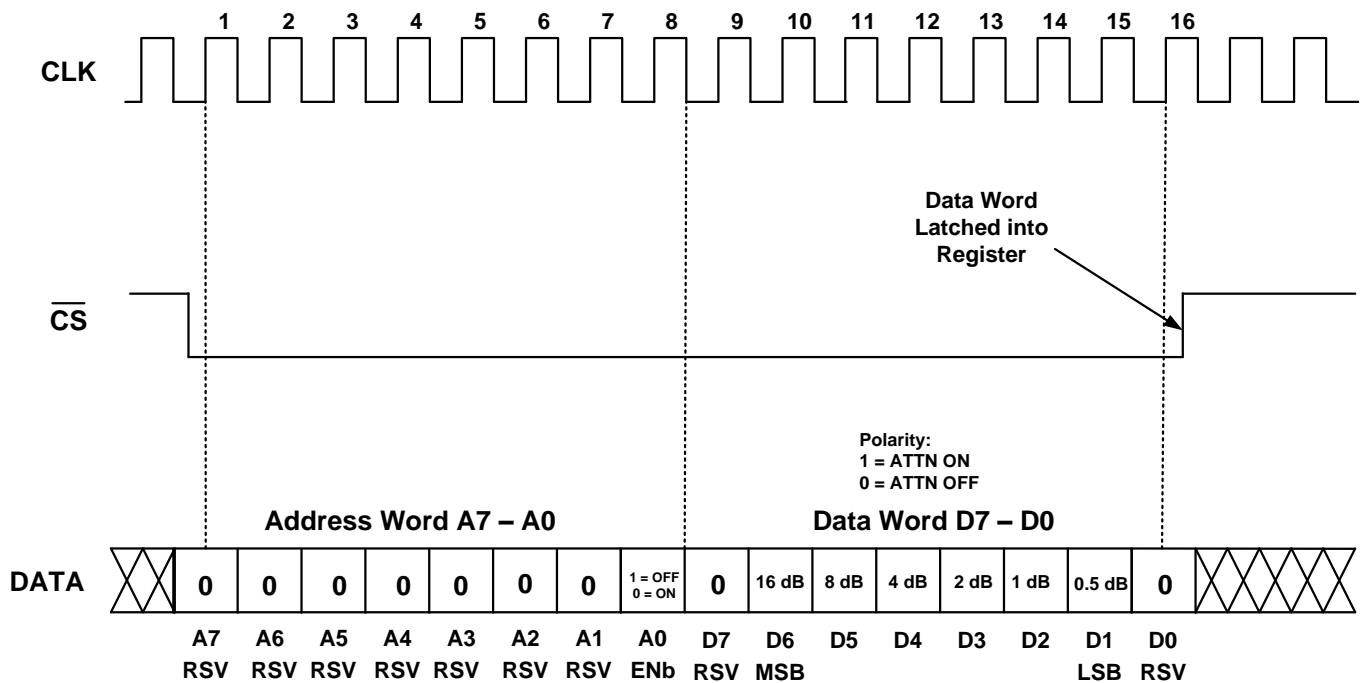

**TO PROGRAM THE SERIAL INTERFACE:**

If CSb is de-asserted (set to high), the serial interface will ignore the CLK line. Once CSb is asserted (set to low), the serial interface will recognize the CLK and any data present on DATA will be clocked into the registers with each rising CLK edge. After the 16<sup>th</sup> CLK cycle, and before the 17<sup>th</sup> CLK cycle, CSb must be de-asserted to successfully program the part with the desired bytes. If CSb is de-asserted before the 16<sup>th</sup> CLK cycle, or after the 17<sup>th</sup> CLK cycle, there is no guarantee that the correct bytes will be programmed and the user will have to re-program the interface in accordance with the aforementioned procedure.

**SW\_LATCH PROGRAMMING SEQUENCE**

- When SW\_LATCH is pinned high during the programming sequence, “ENb” registers cannot be programmed and therefore will not toggle.
- If SW\_LATCH is pinned low during the programming sequence, the “ENb” register will toggle. This can be prevented with the “Programming Sequence” below.

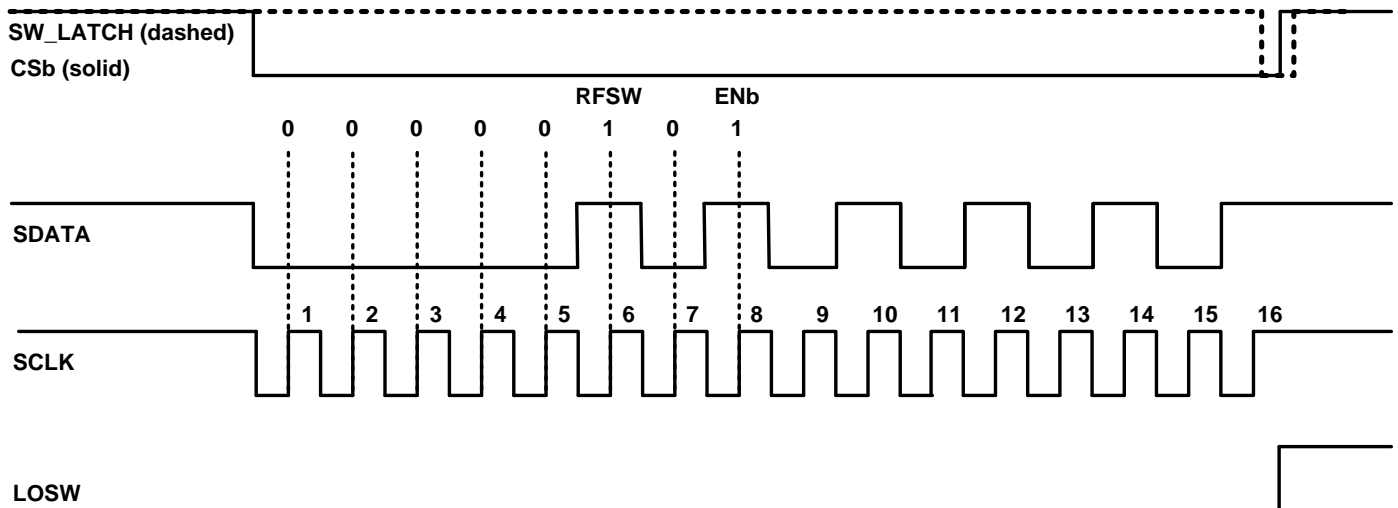

**SEQUENCE FOR PROGRAMMING REGISTERS A<2>:A<0>**

- 1) SW\_Latch = 1; CSb = 0
- 2) CLK in 8- or 16-bit word, *do not de-assert (pull high) CSb*
- 3) Set SW\_LATCH = 0 while CSb = 0 remains)
- 4) With SW\_Latch = 0, set CSb = 1
- 5) Set SW\_Latch = 1
- 6) Program complete

**SPECIAL NOTE REGARDING PHASE OF I & Q:**

- When LO is high-side injected, IF\_I leads IF\_Q by 90 degrees
- When LO is low-side injected, IF\_Q leads IF\_I by 90 degrees

**SERIAL MODE TIMING DIAGRAM ZOOM:**

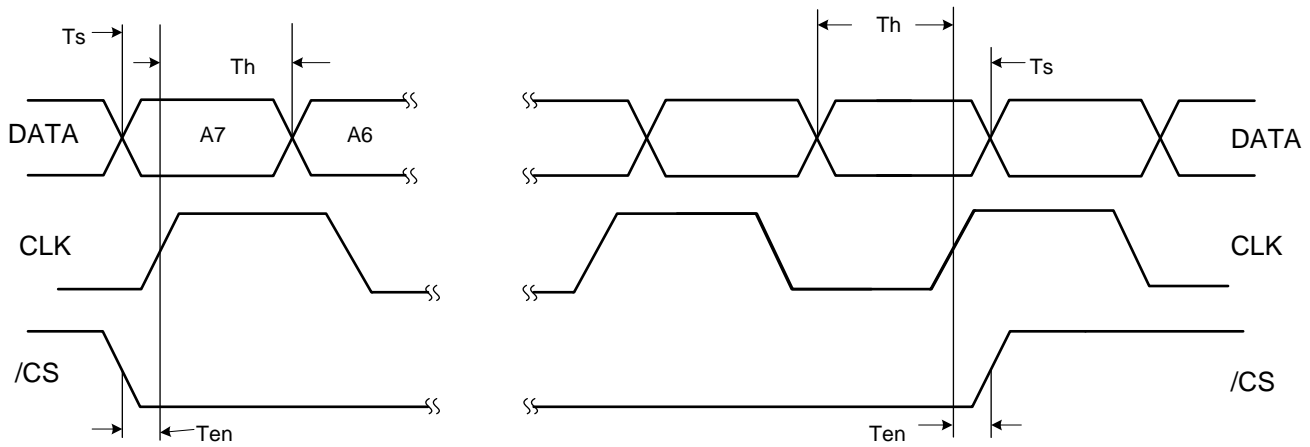

- Data is shifted with the rising edge of CLK when /CS is low
- The rising edge of /CS latches data into the device

**LOGIC TRUTH TABLE:**

STBY	SW_LATCH	MODE	WRITE ACCESS
0	0	Operating Mode	A0 Enabled, D7:D0 Enabled
0	1	Operating Mode	A0 Disabled, D7:D0 Enabled
1	0	Off	A0 Enabled, D7:D0 Enabled
1	1	Off	A0 Disabled, D7:D0 Enabled





**F1325 ATTENUATION TABLE**

The F1325 gain/attenuation setting is controlled by 6 bits in the data word. The device provides an added attenuation range from 0 dB to 25.5 dB in 0.5 dB steps. A “high” or “1” bit corresponds to attenuation stepped IN, while a “low” or “0” bit corresponds to attenuation stepped OUT.

<b>F1325 DPD Demodulator - Attenuation Table (Data Word D7-D0)</b>						
<b>BINARY</b>	<b>HEX</b>	<b>Added Atten (dB)</b>		<b>BINARY</b>	<b>HEX</b>	<b>Added Atten (dB)</b>
00000000	00	0		00110100	34	13
00000010	02	0.5		00110110	36	13.5
00000100	04	1		00111000	38	14
00000110	06	1.5		00111010	3A	14.5
00001000	08	2		00111100	3C	15
00001010	0A	2.5		00111110	3E	15.5
00001100	0C	3		01000000	40	16
00001110	0E	3.5		01000010	42	16.5
00010000	10	4		01000100	44	17
00010010	12	4.5		01000110	46	17.5
00010100	14	5		01001000	48	18
00010110	16	5.5		01001010	4A	18.5
00011000	18	6		01001100	4C	19
00011010	1A	6.5		01001110	4E	19.5
00011100	1C	7		01010000	50	20
00011110	1E	7.5		01010010	52	20.5
00100000	20	8		01010100	54	21
00100010	22	8.5		01010110	56	21.5
00100100	24	9		01011000	58	22
00100110	26	9.5		01011010	5A	22.5
00101000	28	10		01011100	5C	23
00101010	2A	10.5		01011110	5E	23.5
00101100	2C	11		01100000	60	24
00101110	2E	11.5		01100010	62	24.5
00110000	30	12		01100100	64	25
00110010	32	12.5		01100110	66	25.5

Because the first and last bits of the Data Word are not presently used by the F1325, two additional hex character pairs exist in this table. For example, data words of either H00, H80, or H01 (binary “00000000,” “10000000,” or 00000001) will place the F1325 in its minimum attenuation state. Likewise, data words of either H66, HE6, or H67 (binary “01100110” or “11100110” or “01100111”) will place the F1325 in its maximum attenuation state of 25.5 added attenuation.



## TYPICAL OPERATING CONDITIONS (TOC)

Unless otherwise noted, for the TOC graphs, the following conditions apply

- **IF = 200 MHz**
- **Tone spacing = 5 MHz**
- **Pout ~ 1 dBm**
- **Pin = -8 dBm**
- **RF\_X, LO\_A, IF\_I selected**
- **Attenuation Setting = 0 dB (min ATTN or G<sub>MAX</sub>)**
- **T<sub>CASE</sub> = 25 °C**
- **V<sub>CC</sub> = 5.00 V**
- **LO level = 0 dBm**
- **Output Transformer losses are de-embedded**
- **Input RF trace losses are de-embedded**

## TOCs [Fixed IF] (-1-)

### GAIN vs. T<sub>CASE</sub> [*Low Side Injection*]

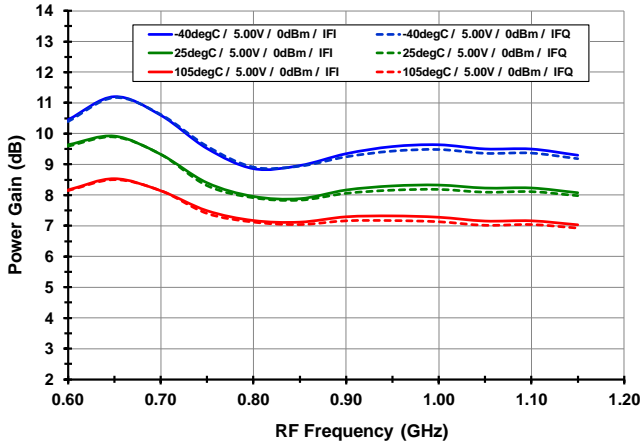

### GAIN vs. T<sub>CASE</sub> [*High Side Injection*]

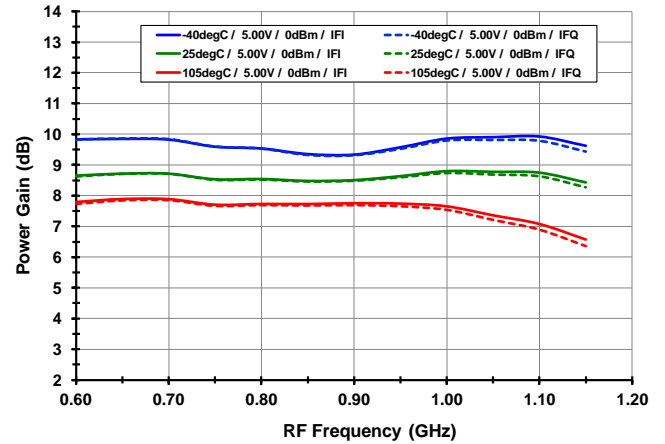

### GAIN vs. V<sub>CC</sub> [*Low Side Injection*]

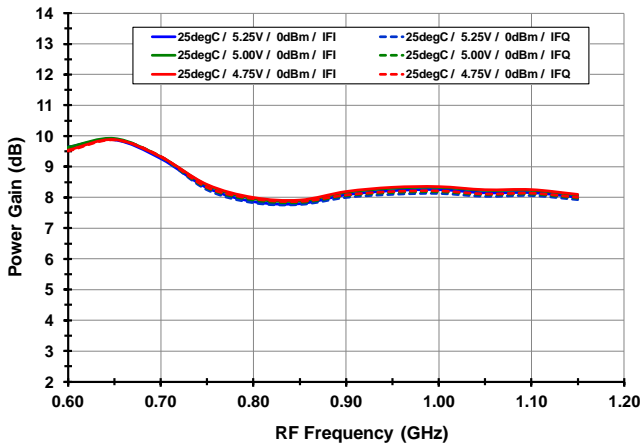

### GAIN vs. V<sub>CC</sub> [*High Side Injection*]

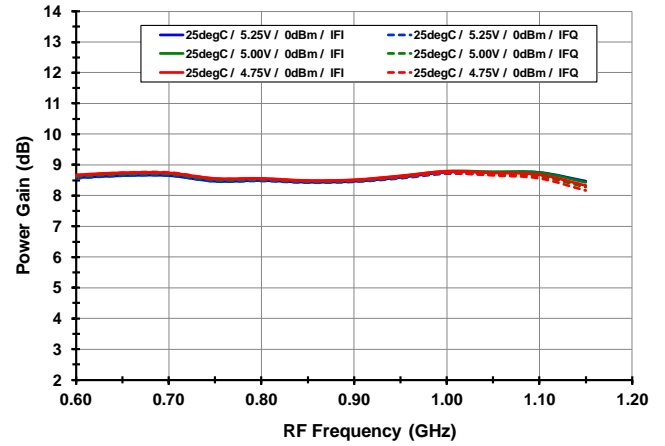

### GAIN vs. LO level [*Low Side Injection*]

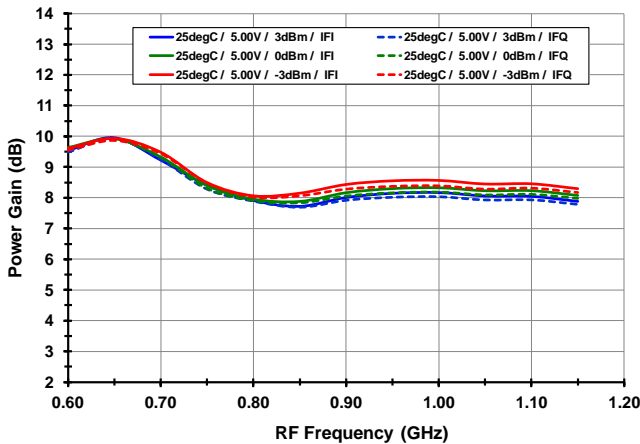

### GAIN vs. LO level [*High Side Injection*]

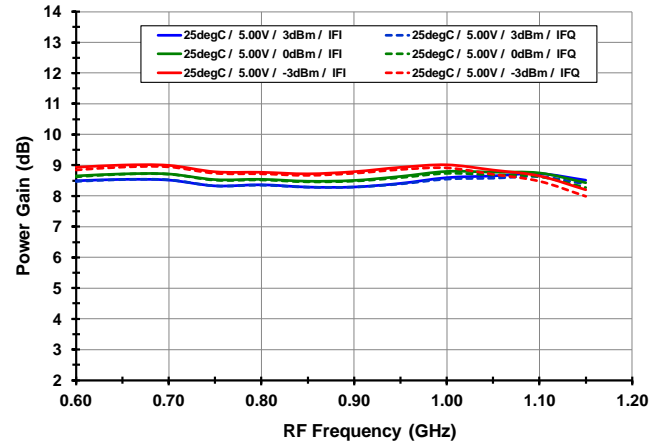

## TOCs [Fixed IF] (-2-)

### OIP3 vs. T<sub>CASE</sub> [Low Side Injection]

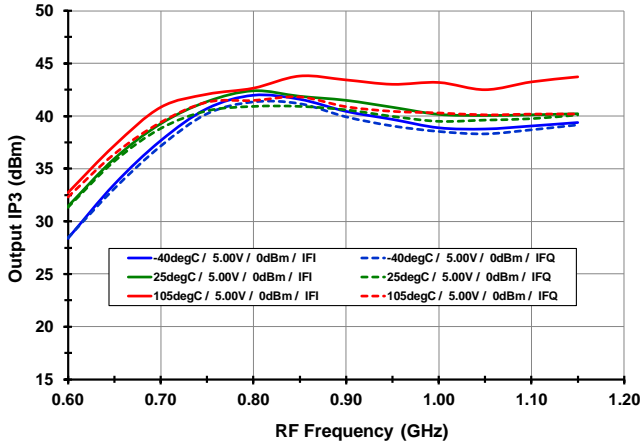

### OIP3 vs. T<sub>CASE</sub> [High Side Injection]

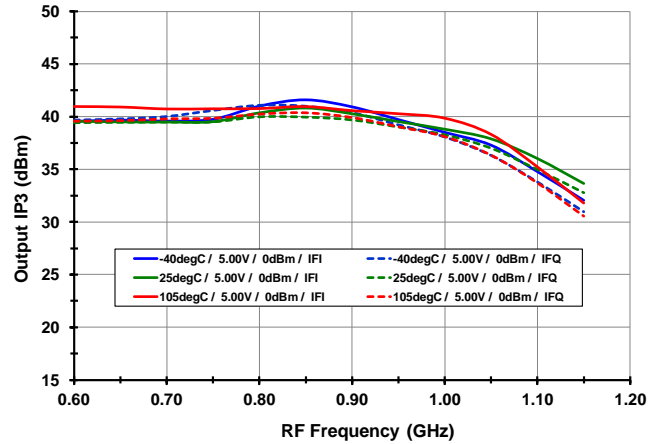

### OIP3 vs. V<sub>CC</sub> [Low Side Injection]

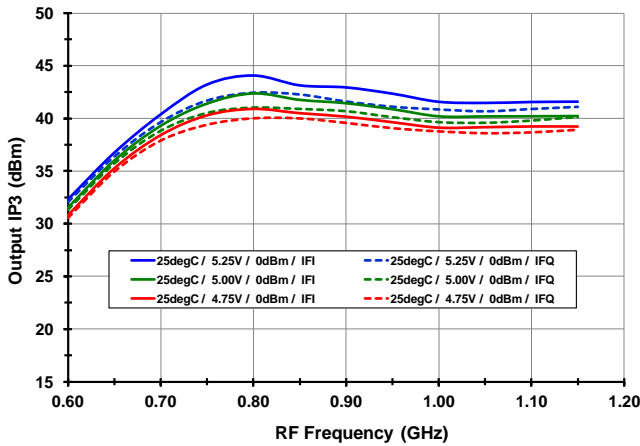

### OIP3 vs. V<sub>CC</sub> [High Side Injection]

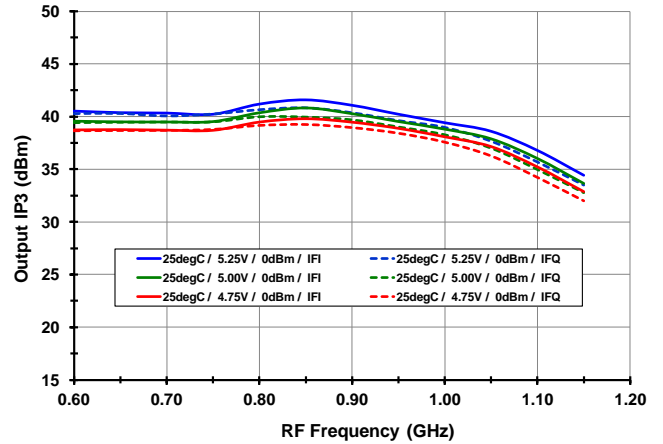

### OIP3 vs. LO level [Low Side Injection]

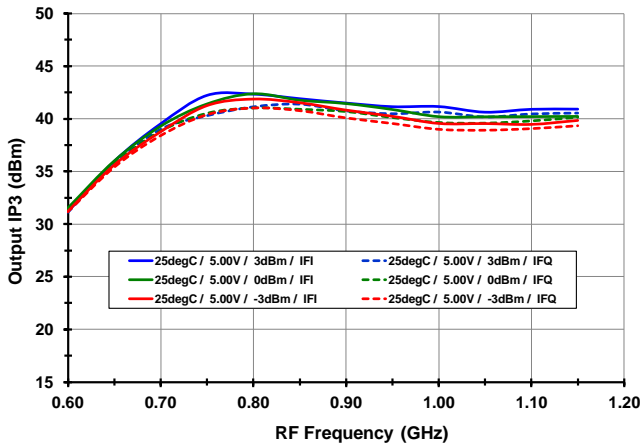

### OIP3 vs. LO level [High Side Injection]

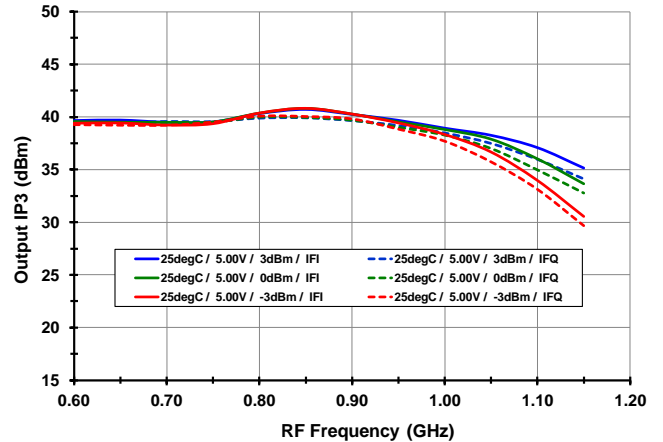

## TOCs [Fixed IF] (-3-)

### OIP2 vs. T<sub>CASE</sub> [Low Side Injection]

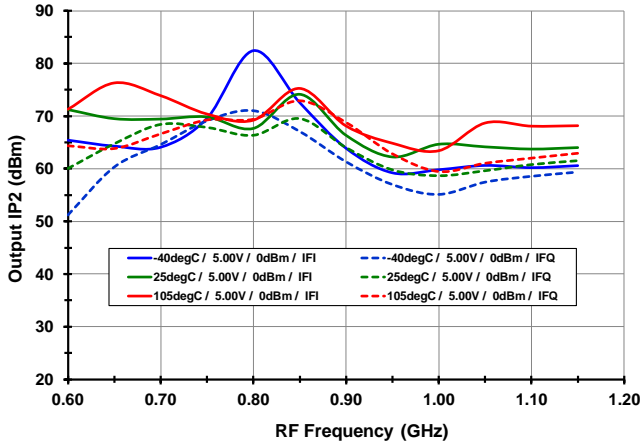

### OIP2 vs. T<sub>CASE</sub> [High Side Injection]

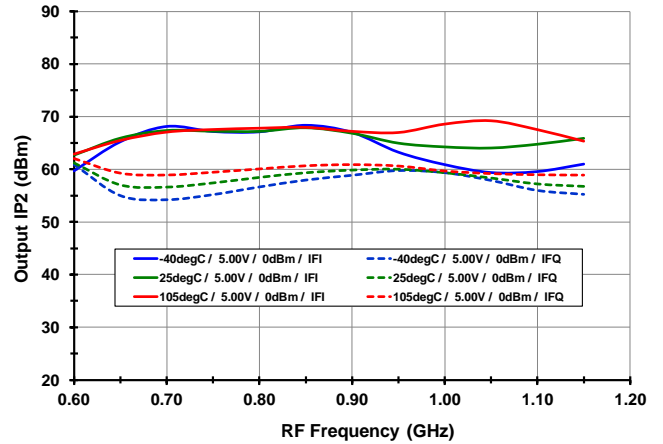

### OIP2 vs. V<sub>CC</sub> [Low Side Injection]

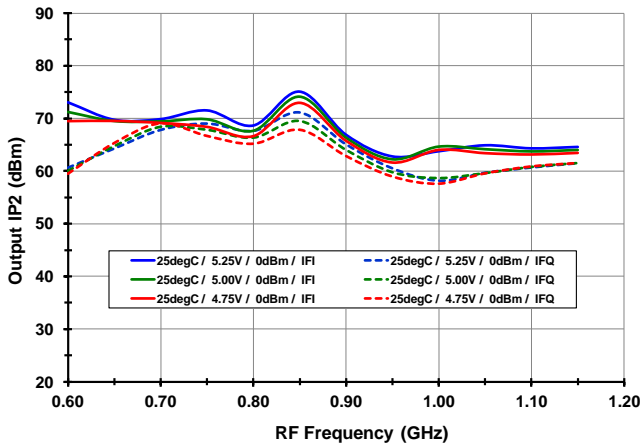

### OIP2 vs. V<sub>CC</sub> [High Side Injection]

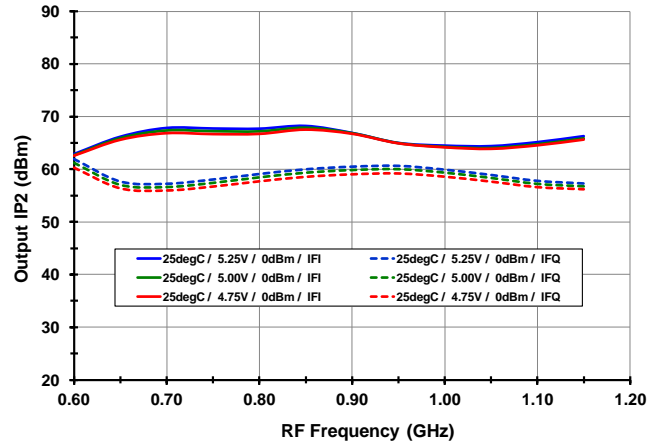

### OIP2 vs. LO level [Low Side Injection]

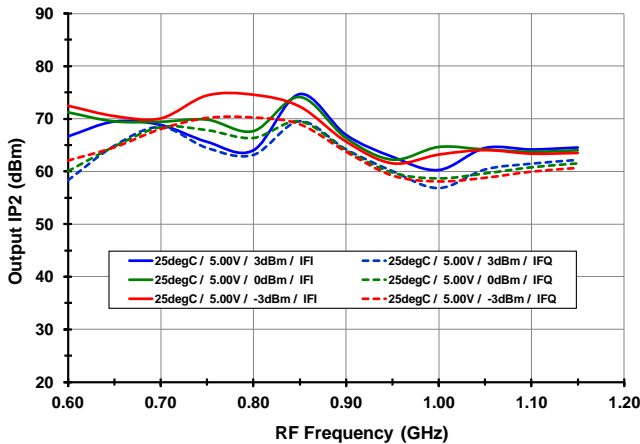

### OIP2 vs. LO level [High Side Injection]

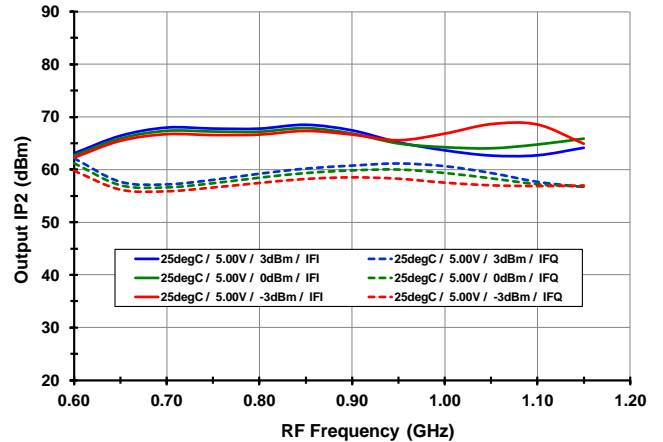

## TOCs [Fixed IF] (-4-)

### OP1dB vs. T<sub>CASE</sub> [*Low Side Injection*]

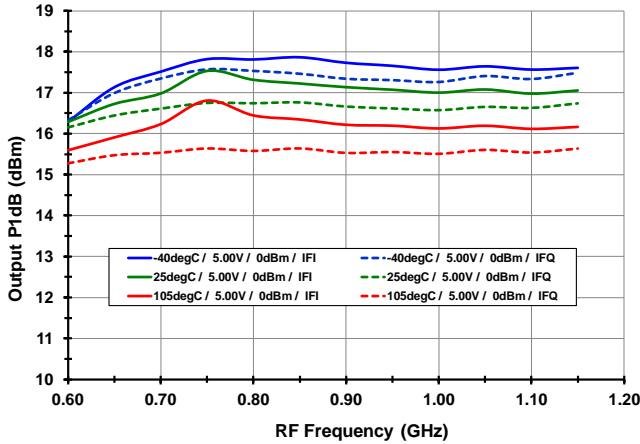

### OP1dB vs. T<sub>CASE</sub> [*High Side Injection*]

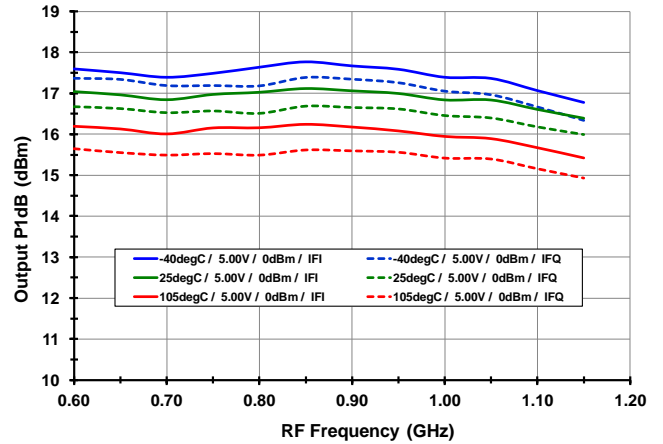

### OP1dB vs. V<sub>CC</sub> [*Low Side Injection*]

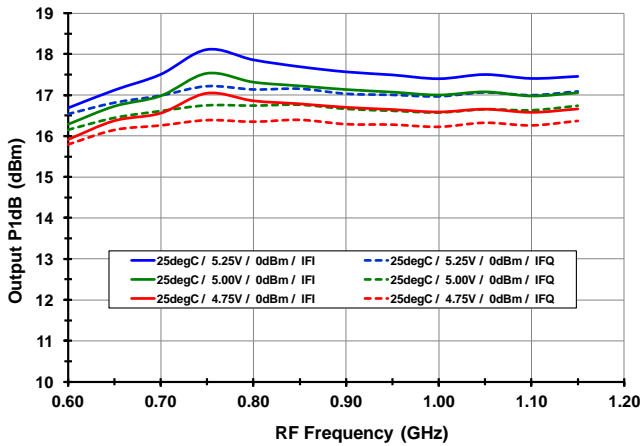

### OP1dB vs. V<sub>CC</sub> [*High Side Injection*]

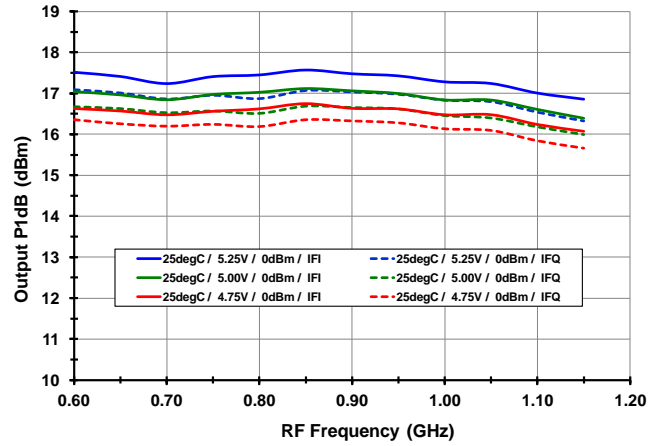

### OP1dB vs. LO level [*Low Side Injection*]

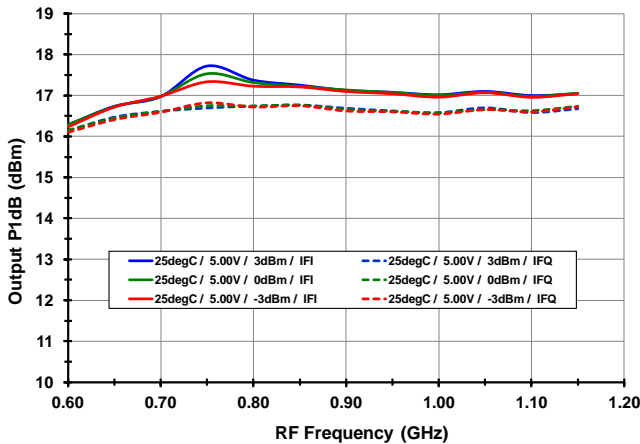

### OP1dB vs. LO level [*High Side Injection*]

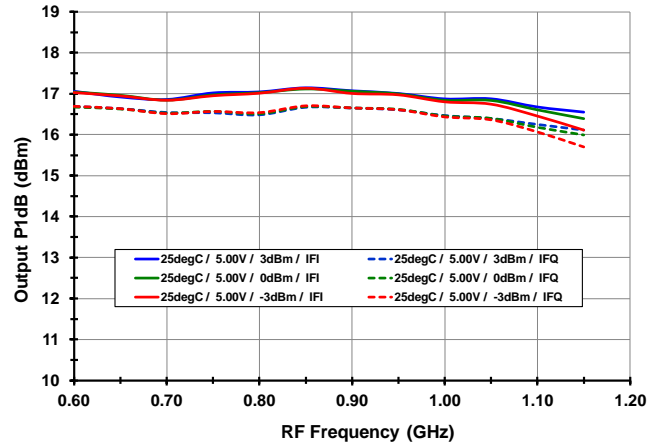

## TOCs [Fixed IF = 200 MHz] (-5-)

### LO to IF vs. $T_{CASE}$ [*Low Side Injection*]

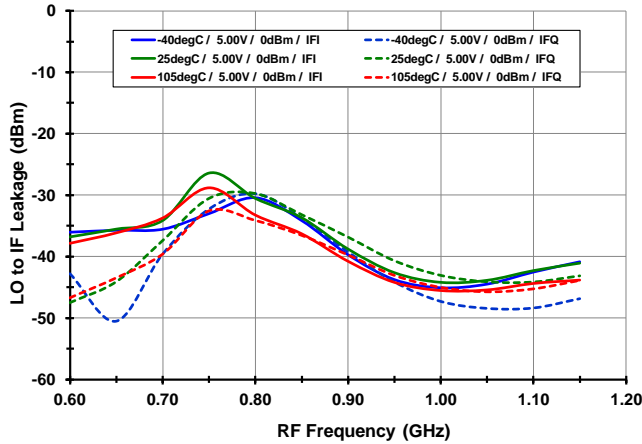

### LO to IF vs. $T_{CASE}$ [*High Side Injection*]

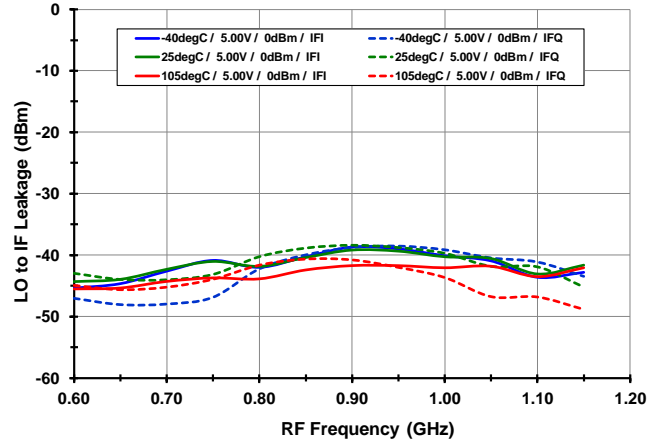

### LO to IF vs. $V_{CC}$ [*Low Side Injection*]

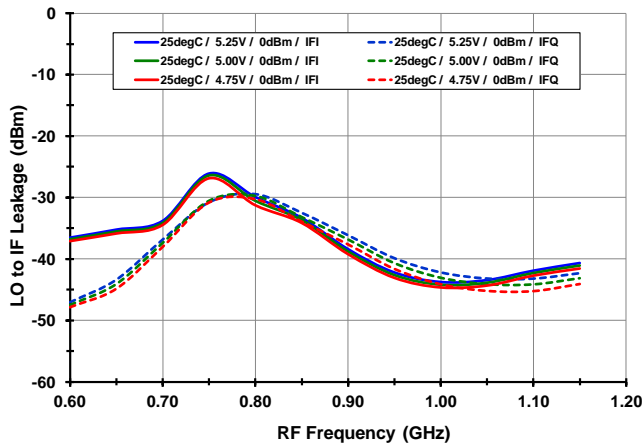

### LO to IF vs. $V_{CC}$ [*High Side Injection*]

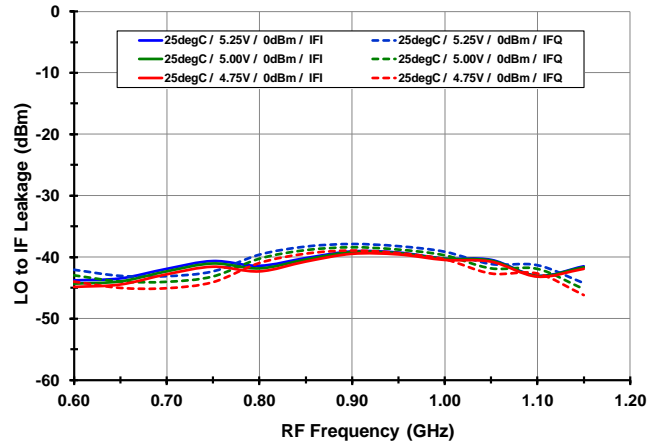

### LO to IF vs. LO level [*Low Side Injection*]

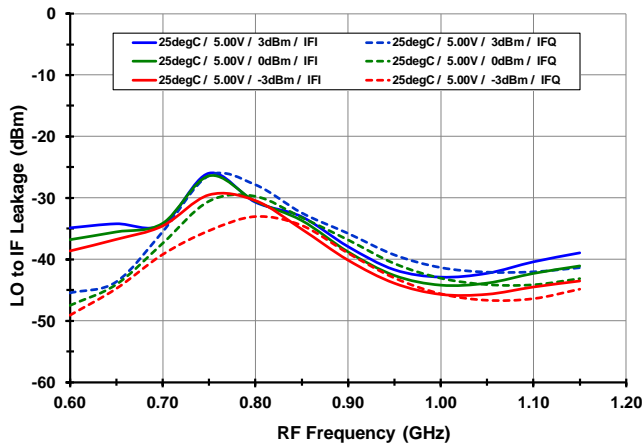

### LO to IF vs. LO level [*High Side Injection*]

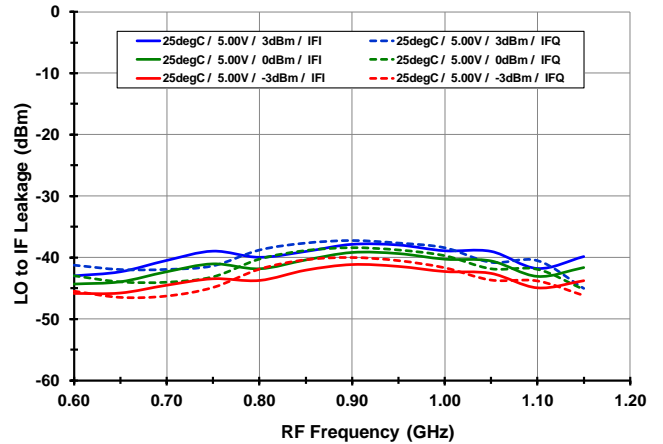

## TOCs [Fixed IF] (-6-)

### $I_{CC}$ vs. $T_{CASE}$ [*Low Side Injection*]

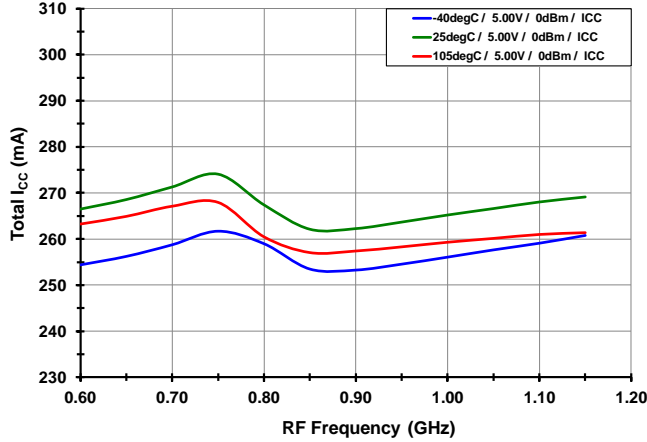

### $I_{CC}$ vs. $T_{CASE}$ [*High Side Injection*]

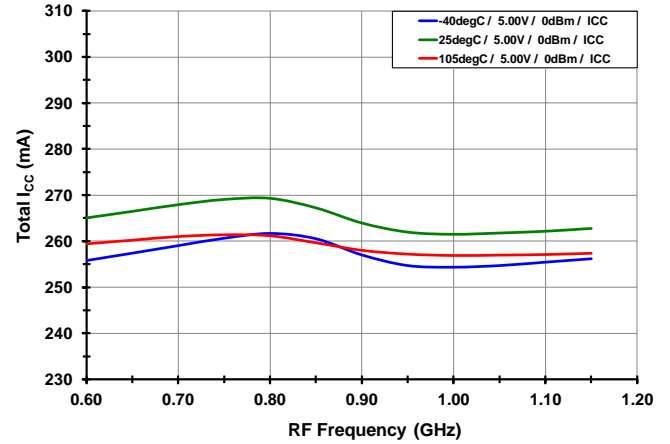

### $I_{CC}$ vs. $V_{CC}$ [*Low Side Injection*]

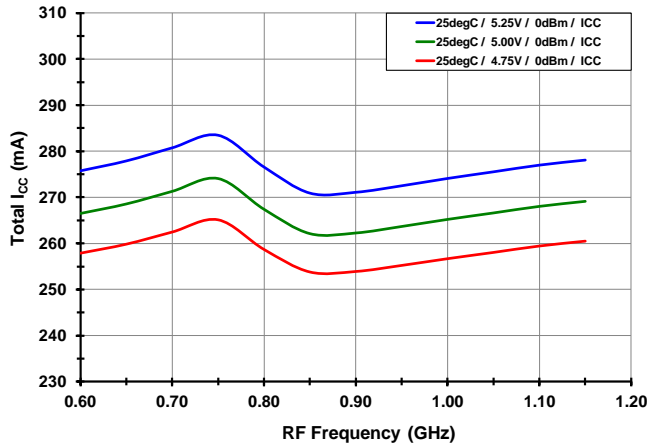

### $I_{CC}$ vs. $V_{CC}$ [*High Side Injection*]

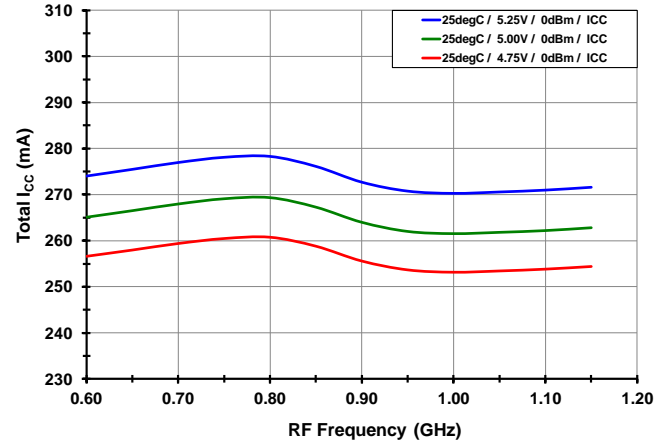

### $I_{CC}$ vs. LO level [*Low Side Injection*]

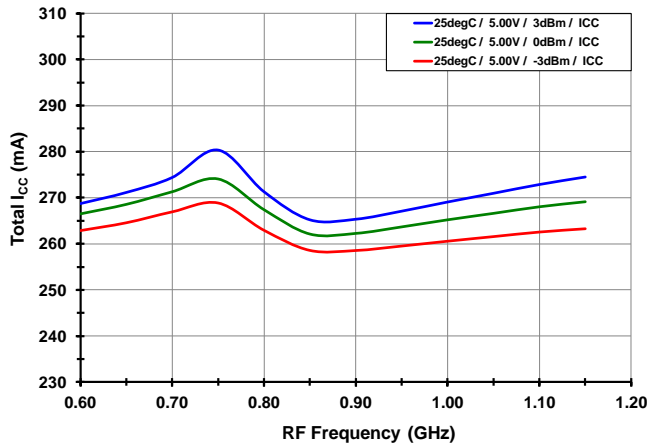

### $I_{CC}$ vs. LO level [*High Side Injection*]

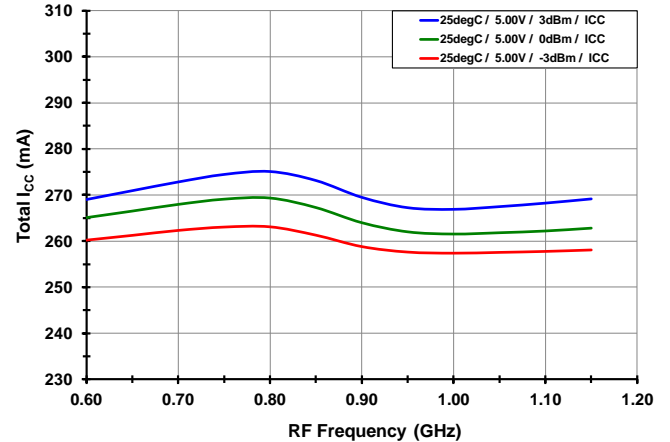



## TOCs [vs. Switch Configuration, Extreme Conditions] (-7-)

**Gain [High Side Injection]**

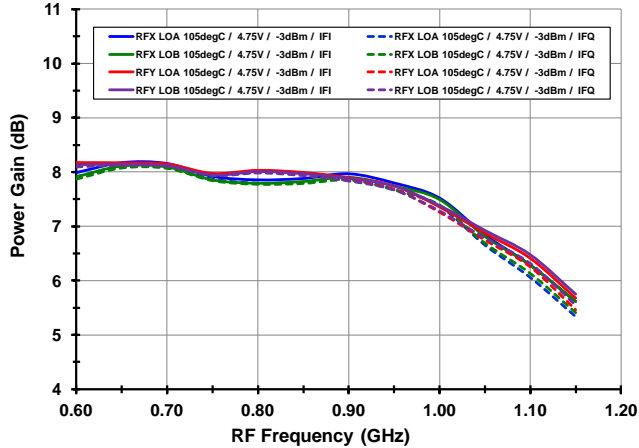

**OIP3 [High Side Injection]**

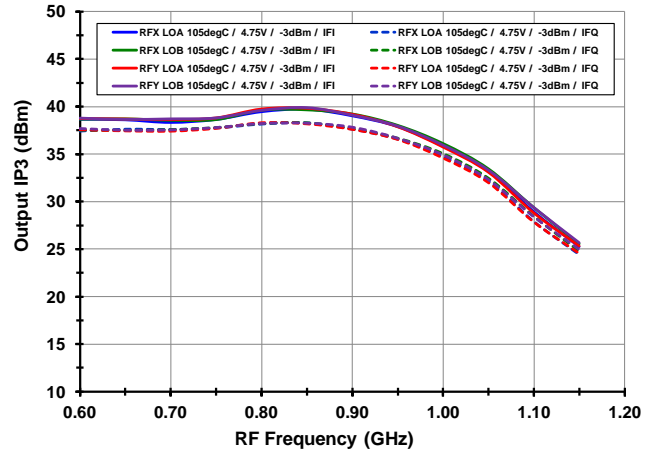

**OIP2 [High Side Injection]**

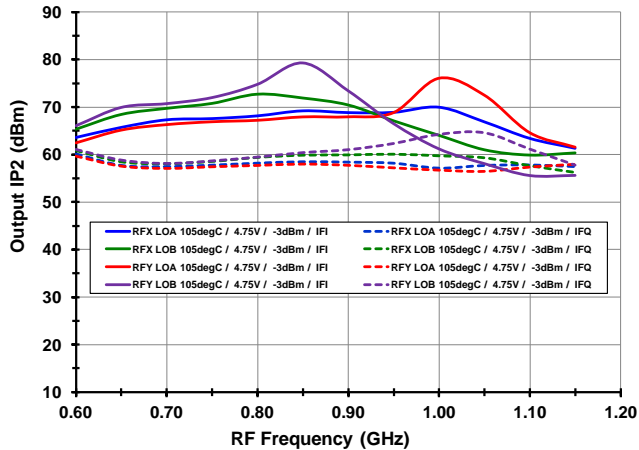

**OP1dB [High Side Injection]**

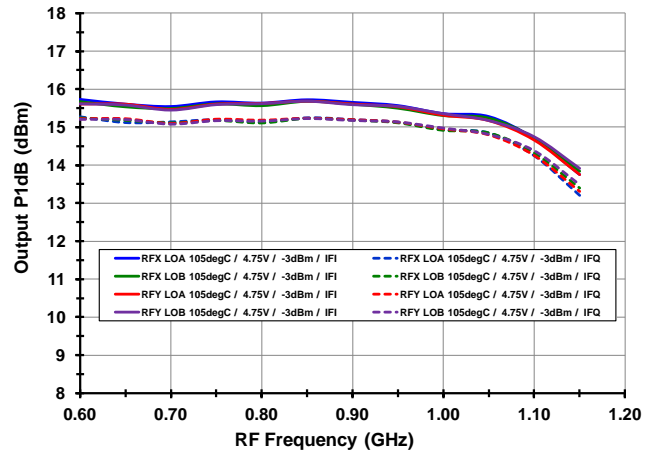

**LO to IF [High Side Injection IF = 200 MHz]**

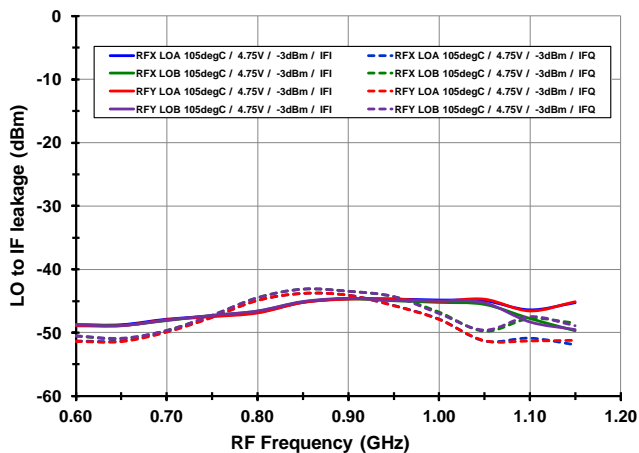

**RF to IF [High Side Injection]**

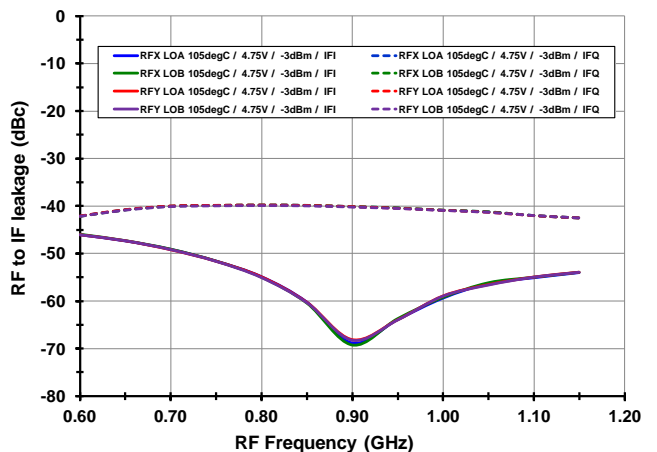

## TOCs [Fixed LO] (-8-)

### Gain Flatness [High Side Injection, RF\_X LO\_A]

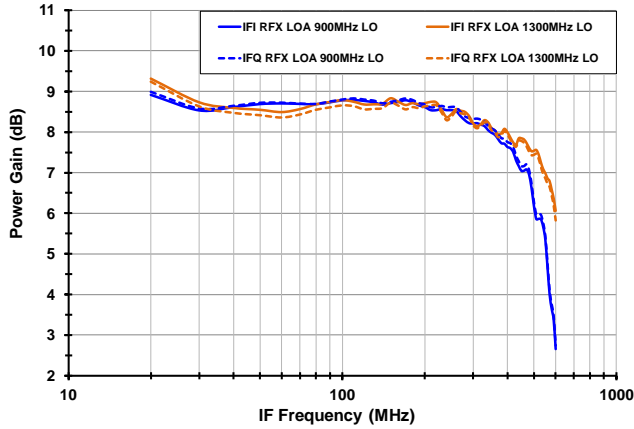

### Gain Flatness [High Side Injection, RF\_Y LO\_B]

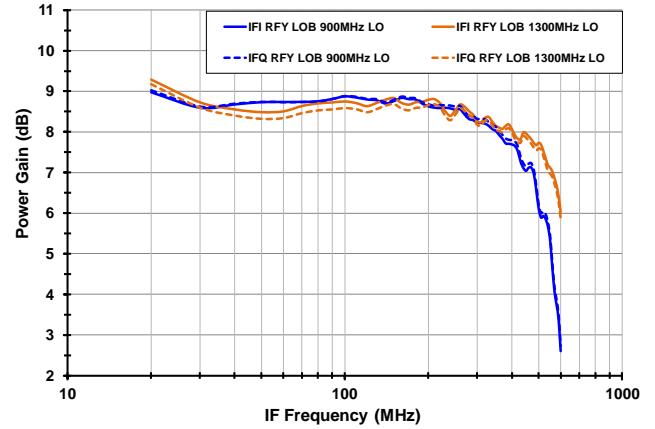

### OIP3 Flatness [High Side Injection, RF\_X LO\_A]

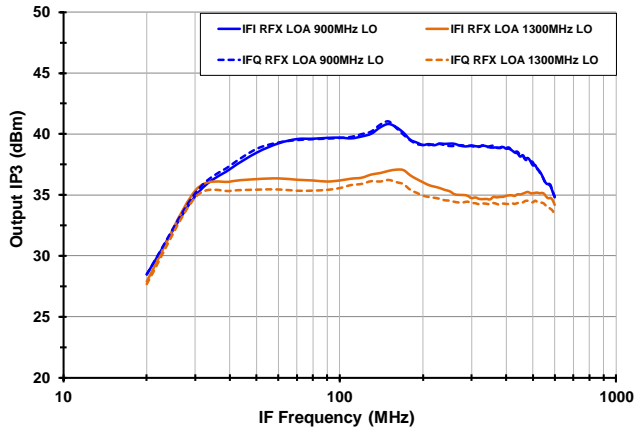

### OIP3 Flatness [High Side Injection, RF\_Y LO\_B]

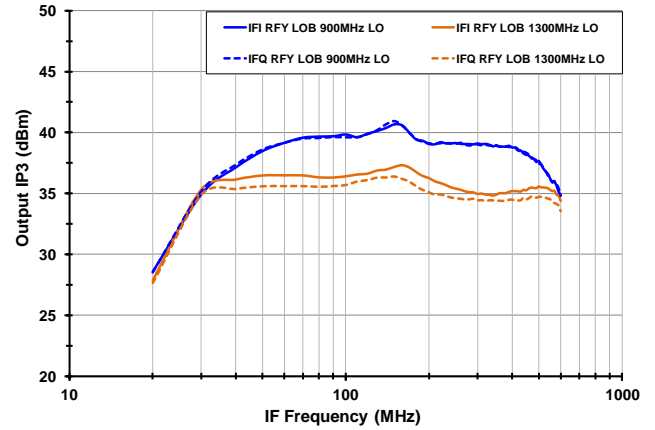

### OIP2 Flatness [High Side Injection, RF\_X LO\_A]

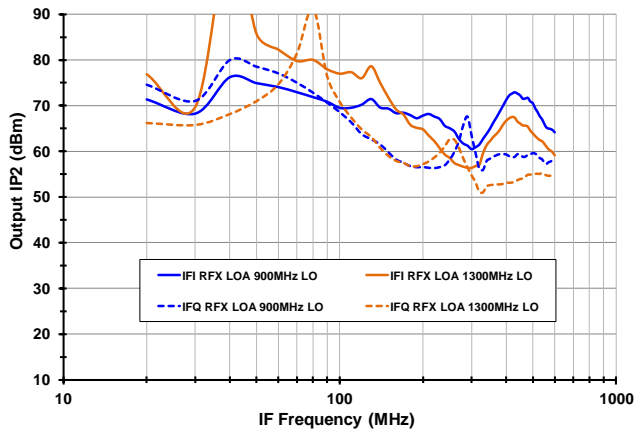

### OIP2 Flatness [High Side Injection, RF\_Y LO\_B]

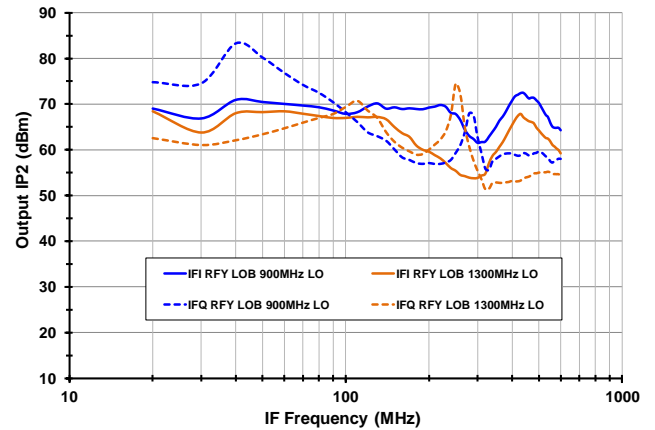

## TOCs [vs. ATTN Setting, 200 MHz IF] (-9-)

### ATTN Accuracy [0.8 GHz RF, *HiSide* Inj.]

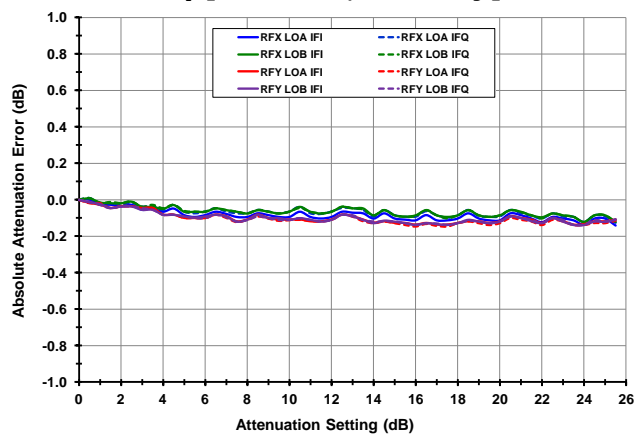

### ATTN Accuracy [1.0 GHz RF, *HiSide* Inj.]

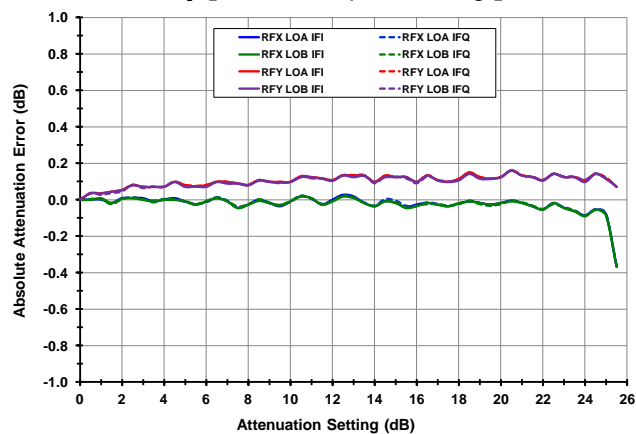

### OIP3 [0.8 GHz RF, *HiSide* Inj.]

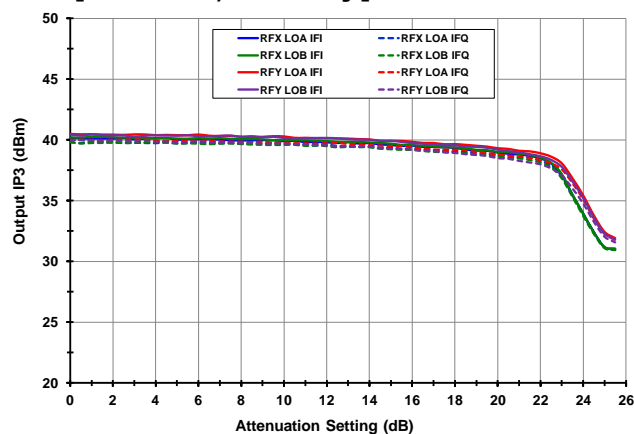

### OIP3 [1.0 GHz RF, *HiSide* Inj.]

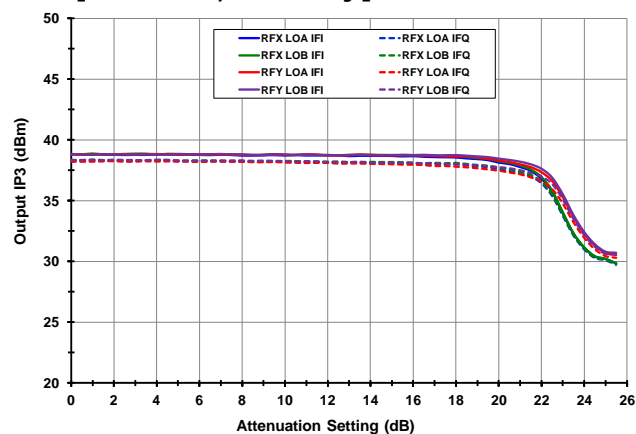

### OIP2 [0.8 GHz RF, *HiSide* Inj.]

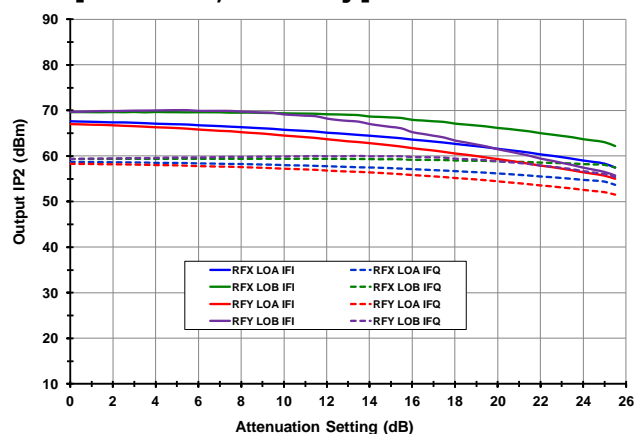

### OIP2 [1.0 GHz RF, *HiSide* Inj.]

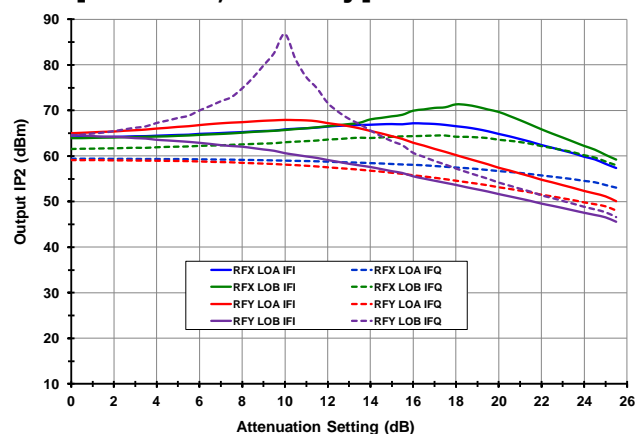

## TOCs [Quadrature] (-10-)

### I/Q Phase Error vs. LO Level & T<sub>CASE</sub>

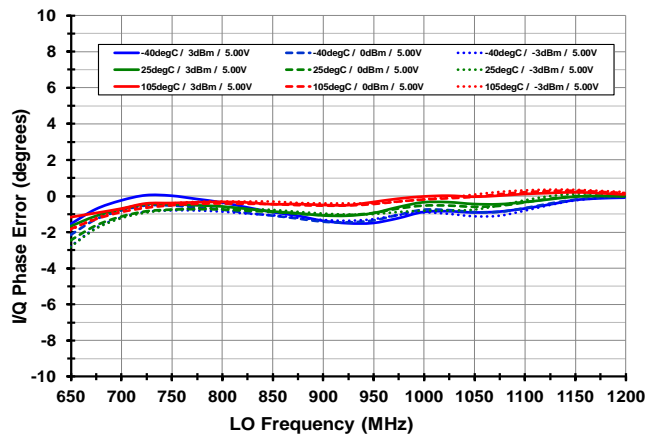

### I/Q Amplitude Error vs. LO Level & T<sub>CASE</sub>

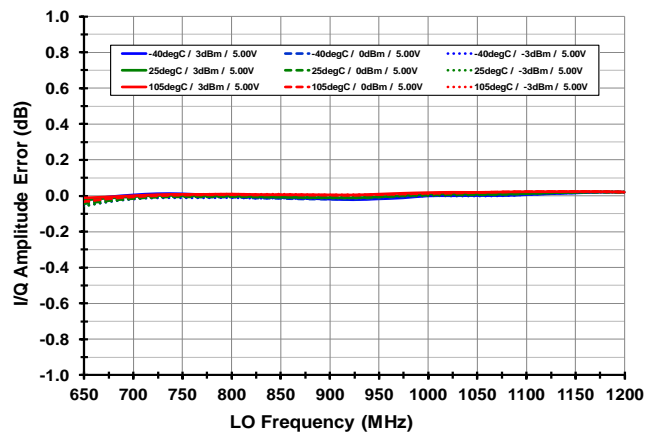

### I/Q Phase Error vs. V<sub>CC</sub> & T<sub>CASE</sub>

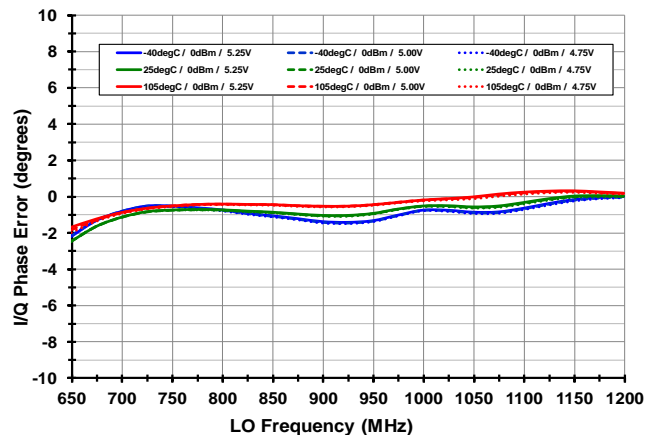

### I/Q Amplitude Error vs. V<sub>CC</sub> & T<sub>CASE</sub>

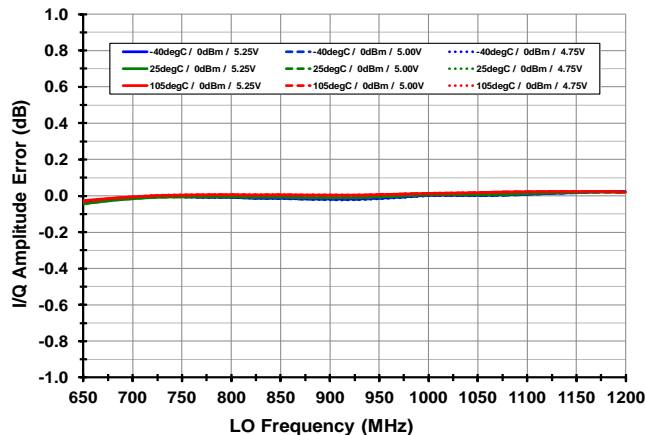

### I/Q Image Rejection vs. LO Level & T<sub>CASE</sub>

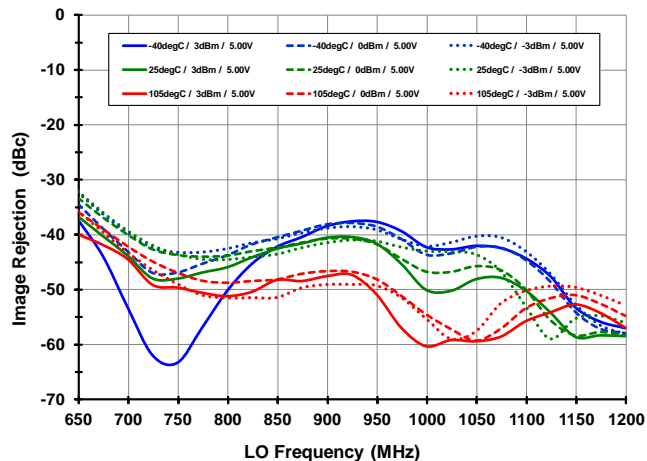

### I/Q Image Rejection vs. V<sub>CC</sub> & T<sub>CASE</sub>

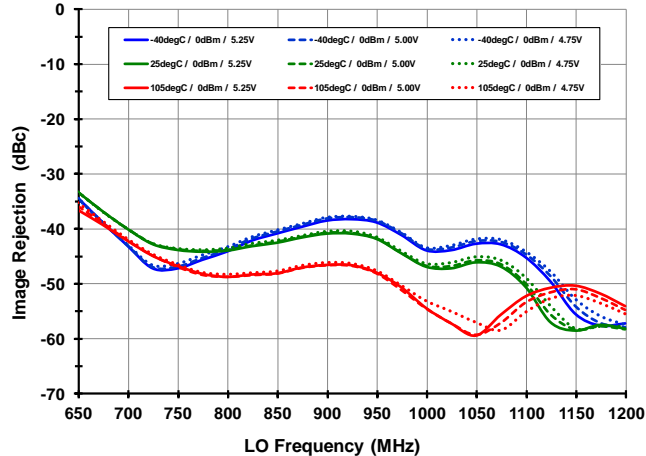

## TOCs [NF, Switch Isolation, Port Matches] (-11-)

### Noise Figure

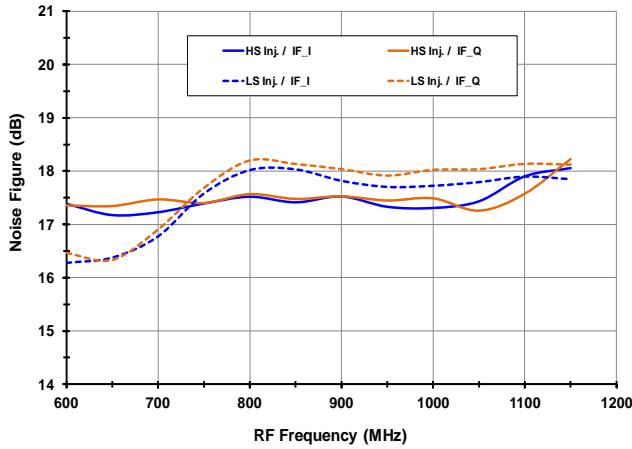

### LO Switch Isolation (absorptive switch)

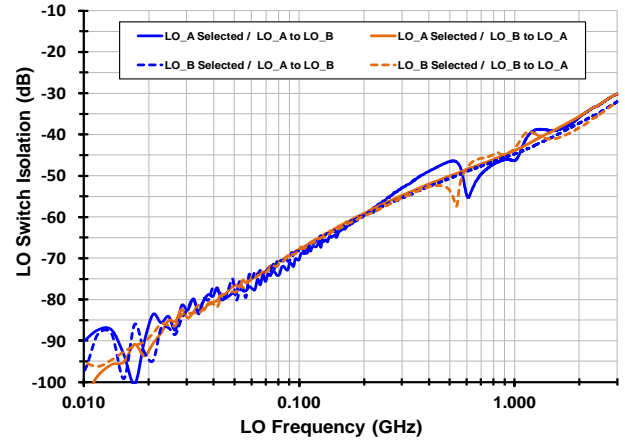

### RF Switch Isolation (reflective switch)

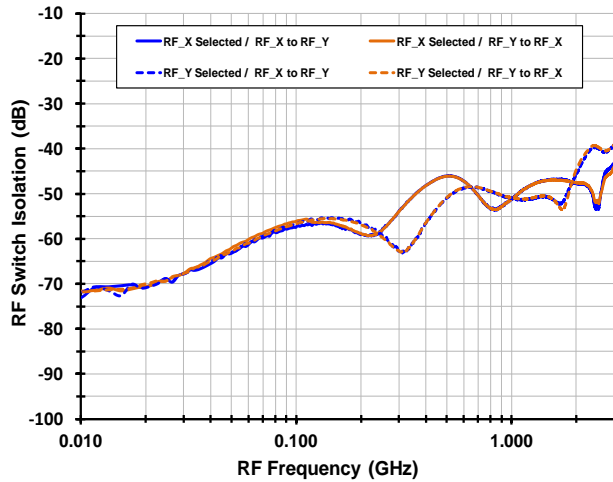

### RF Port Return Loss [LO=1.06 GHz, LOA selected]

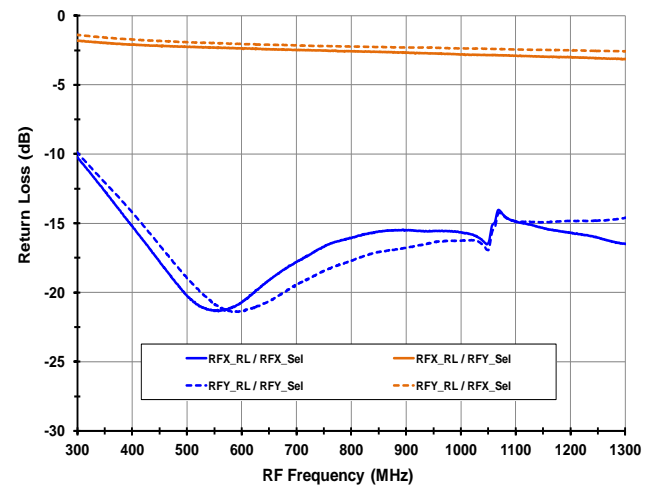

### LO Port Return Loss

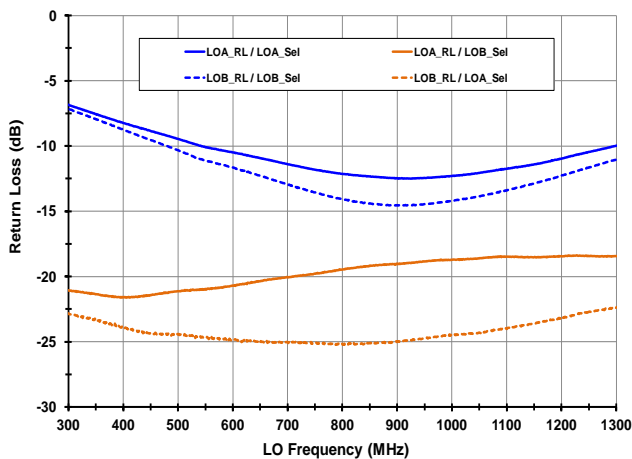

### IF Port Return Loss

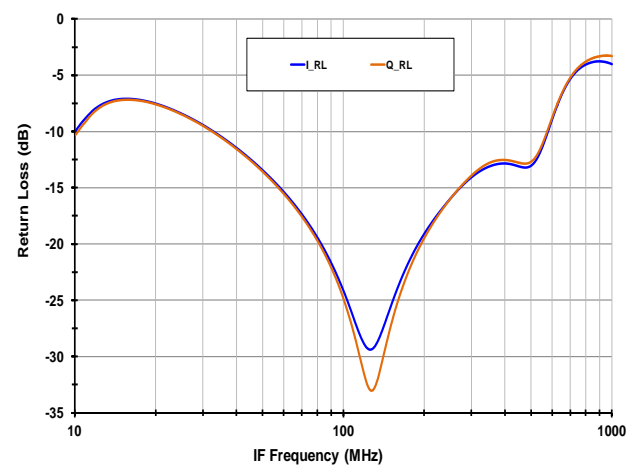

## TOCs [EVKit Losses, Histograms] (-12-)

**IF Output Transformer**

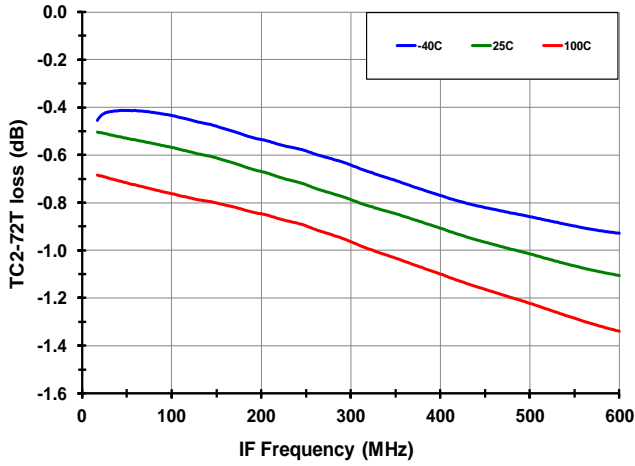

**RF input Traces**

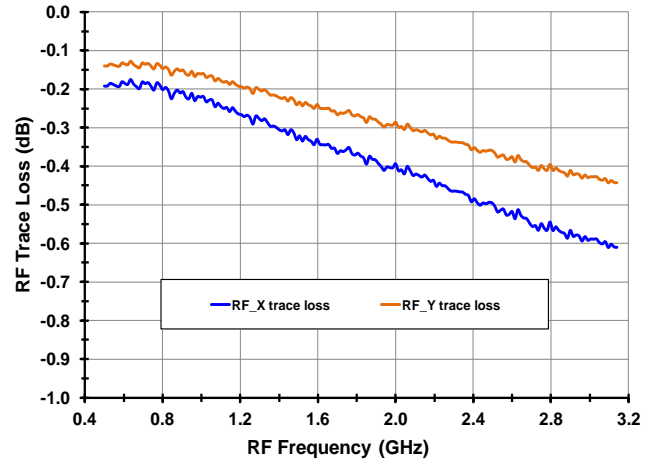

**I/Q Amplitude Balance (N = 2724)**

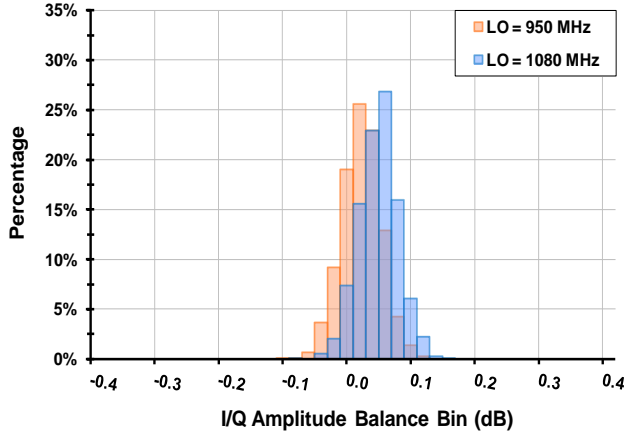

**Output IP3 (N = 2724)**

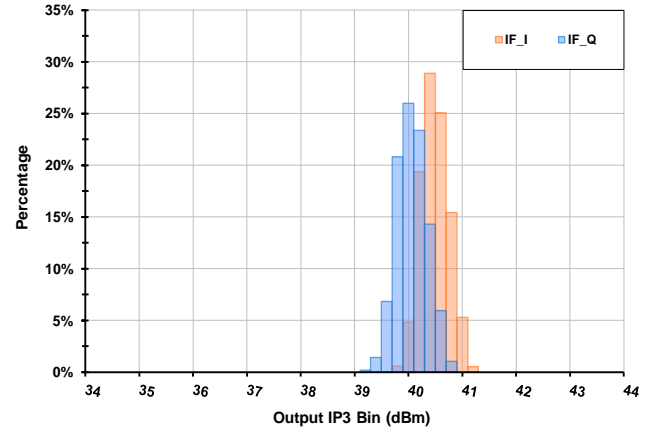



# IDTF1325NBGI Datasheet

DPD Demodulator for PA Linearization

600MHz to 1150MHz

## PACKAGE DRAWING (NBG36 6x6 QFN)

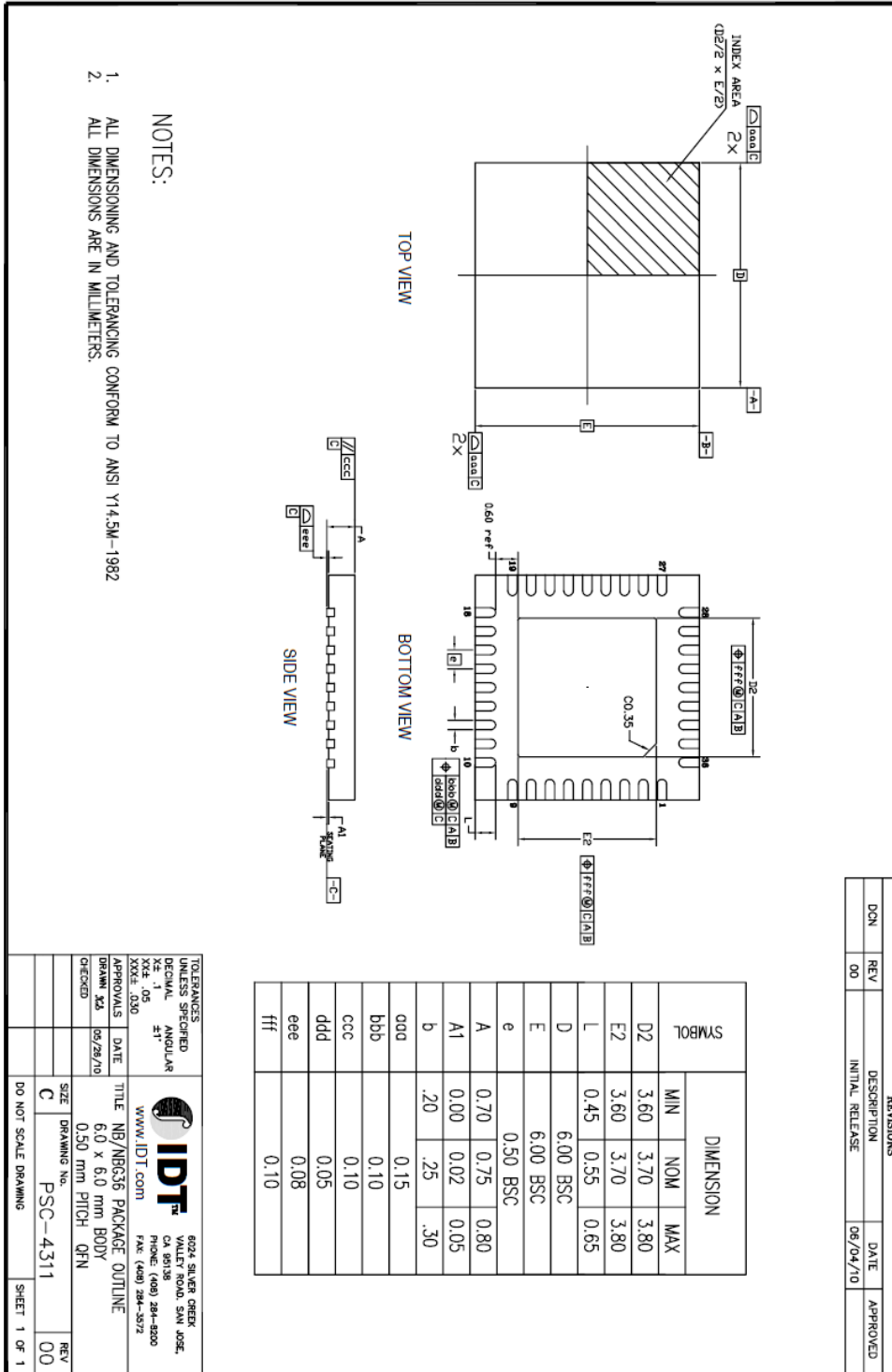

### PIN DIAGRAM

Signal Path Inputs & Outputs in **BLUE**

Switch Latch  
Pull High to Disable writes to:  
A0 in SPI = EN

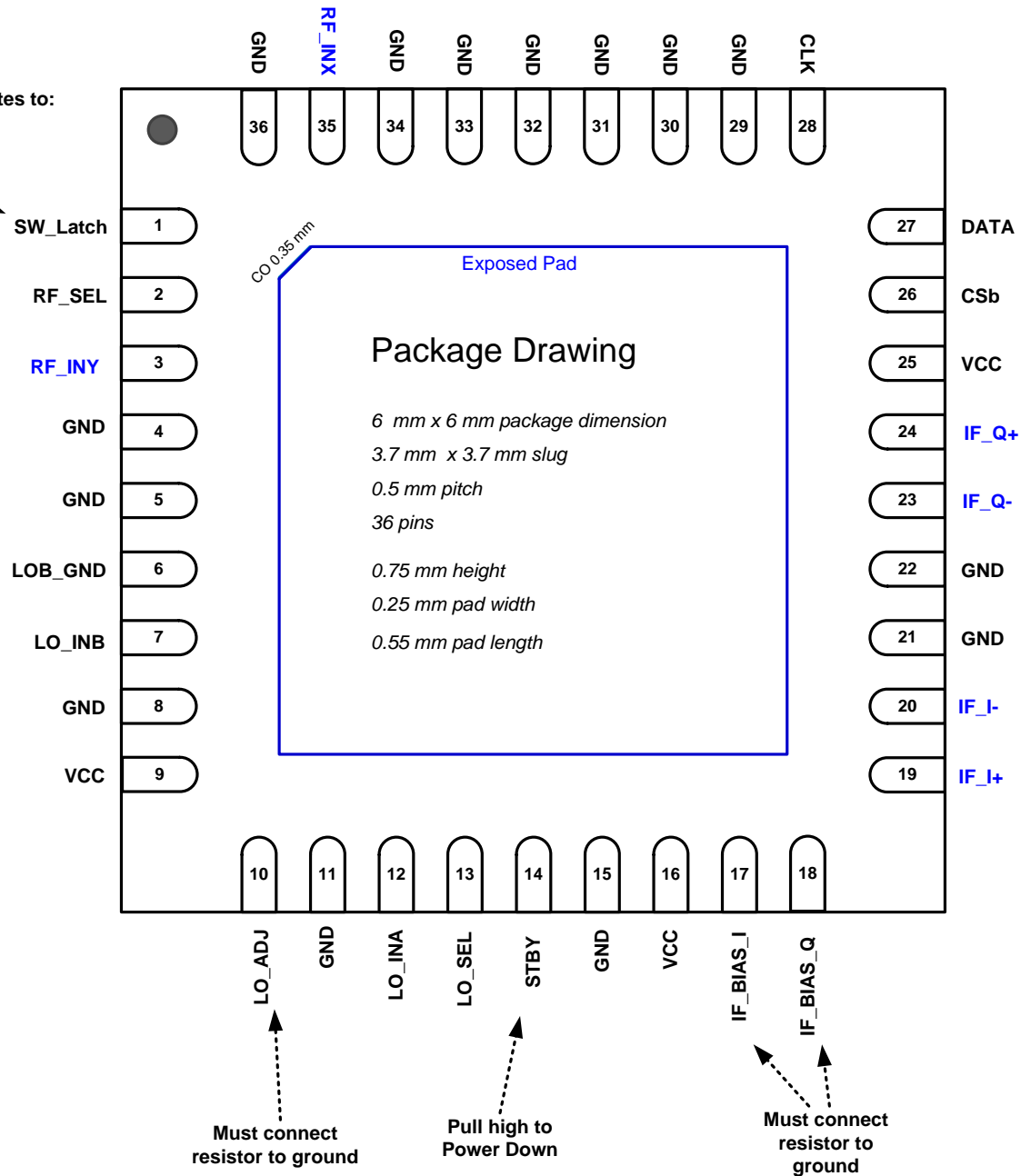



**PIN DESCRIPTIONS**

Pins	Name	Function
1	SW_LATCH	Stand-by latch. Pull Low or Ground for Normal Operation. Pull High to disable SPI writes to ENb settings (A0: ENb).
2	RF_SEL	RF input selection. Logic High if pin left open selects RF_INY. Logic Low selects RF_INX.
3	RF_INY	Alternate RF Input. Separated from RF_INX by internal SP2T. AC couple to this pin. This is a reflective switch. The unselected port is not internally matched to 50 ohms.
4, 5, 8, 11, 15, 21, 22, 30, 31, 32, 33, 34, 36	GND	Ground these Pins.
6	LOB_GND	Ground for LO driver
7	LO_INB	LO Input B. AC couple to this pin. This is an absorptive switch so the unselected port is internally matched to 50 ohms. Selected Logic High via LO_SEL pin.
29,	NC	No Connection. Not internally connected. OK to connect to Vcc. Recommended Connection is Ground
9, 16, 25	VCC	Power Supply. Bypass to GND with capacitors shown in the Typical Application Circuit as close as possible to pin.
10	LO_ADJ	Connect the specified resistor from this pin to ground to set the LO path I <sub>CC</sub> . This IS a current setting resistor
12	LO_INA	LO Input A. AC couple to this pin. This is an absorptive switch so the unselected port is internally matched to 50 ohms. Internally matched to 50 ohms. Selected Logic Low via LO_SEL pin.
13	LO_SEL	LO input selection. Logic High if pin left open selects LO_INB. Logic Low selects LO_INA.
14	STBY	STBY Mode. Pull this pin high for Standby mode (~25 mA). Pull low or Ground for normal Operation
17, 18	IF_BIAS_I IF_BIAS_Q	Connect the specified resistor from this pin to ground to set the IF amplifier bias reference. This is NOT a current setting resistor
19, 20	IF_I+, IF_I-	<i>In-Phase</i> Mixer Differential IF Output. Connect pullup inductors from each of these pins to V <sub>CC</sub> (see the Typical Application Circuit).
23, 24	IF_Q-, IF_Q+	<i>Quadrature</i> Mixer Differential IF Output. Connect pullup inductors from each of these pins to V <sub>CC</sub> (see the Typical Application Circuit).
26	CSb	Chip Select Bar. The falling edge initiates a programming cycle and the rising edge latches the programmed shift register data into the active register.
27	DATA	Serial Data Input
28	CLK	Serial Clock Input
35	RF_INX	Main RF Input. Separated from RF_INY by internal SP2T. AC couple to this pin. This is a reflective switch. The unselected port is not internally matched to 50 ohms.
	— EP	Exposed Pad. Internally connected to GND. Solder this exposed pad to a PCB pad that uses multiple ground vias to provide heat transfer out of the device into the PCB ground planes. These multiple via grounds are also required to achieve the noted RF performance.



**CONTROL PIN VOLTAGE & RESISTANCE VALUES (PINS NOT CONNECTED)**

The following table provides open-circuit DC voltage and resistance values referenced to ground for each of the control pins listed.

Pin	Name	DC voltage (volts)	Resistance (ohms)
1	SW_LATCH	1.75	1.6M
2	RF_SEL	1.75	800K
13	LO_SEL	5	50K
14	STBY	5	50K
26	CSb	1.75	1.6M
27	DATA	1.75	1.6M
28	CLK	1.75	1.6M

**POWER SUPPLIES**

All supply pins should be bypassed with external capacitors to minimize noise and fast transients. Supply noise can degrade noise figure and fast transients can trigger ESD clamps and cause them to fail. Supply voltage change or transients should have a slew rate smaller than 1V/20uS. In addition, all control pins should remain at 0V (+/-0.3V) while the supply voltage ramps or while it returns to zero.

### EVKIT PICTURE / LAYOUT / OPERATION

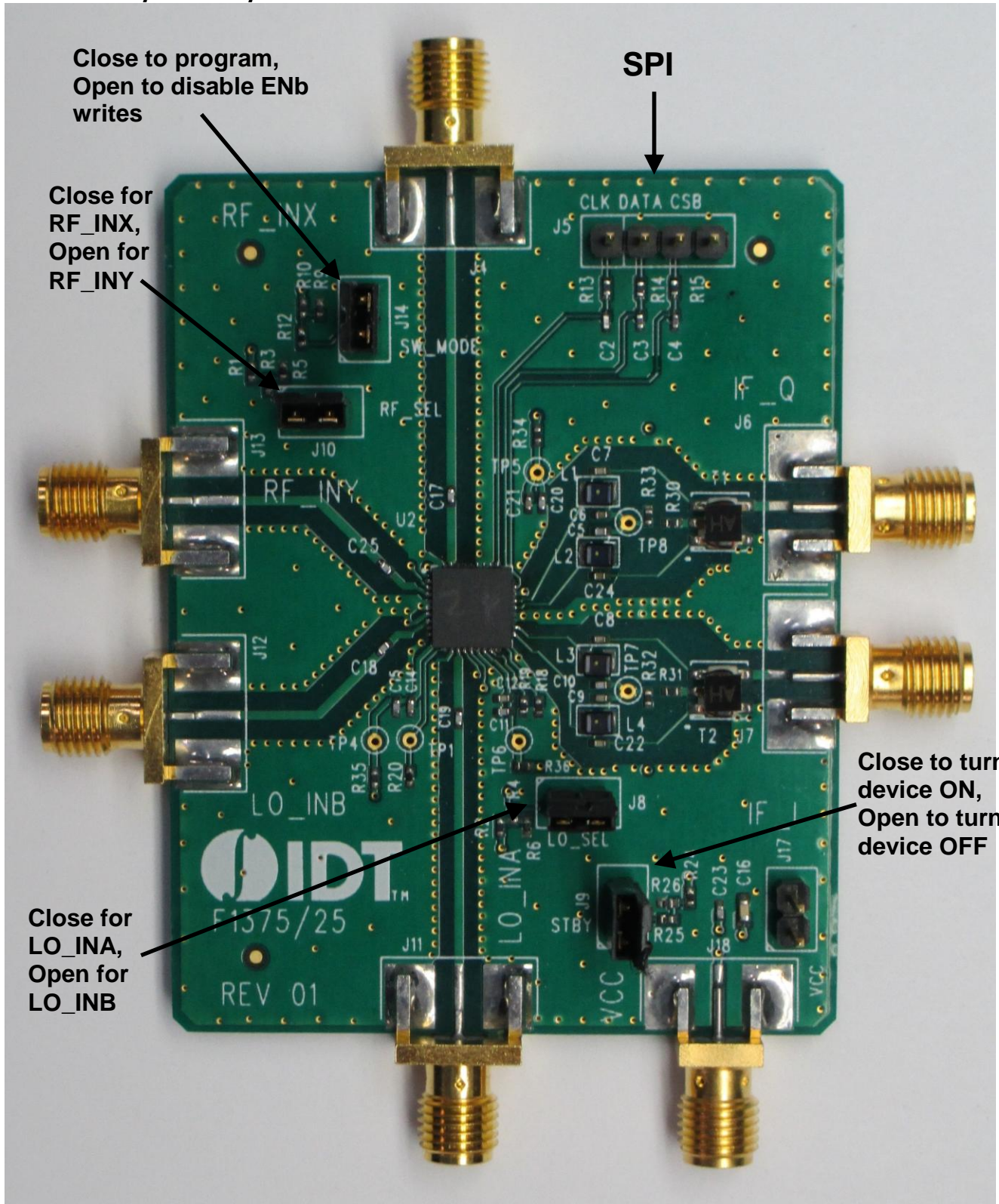

## EVKIT / APPLICATIONS CIRCUIT

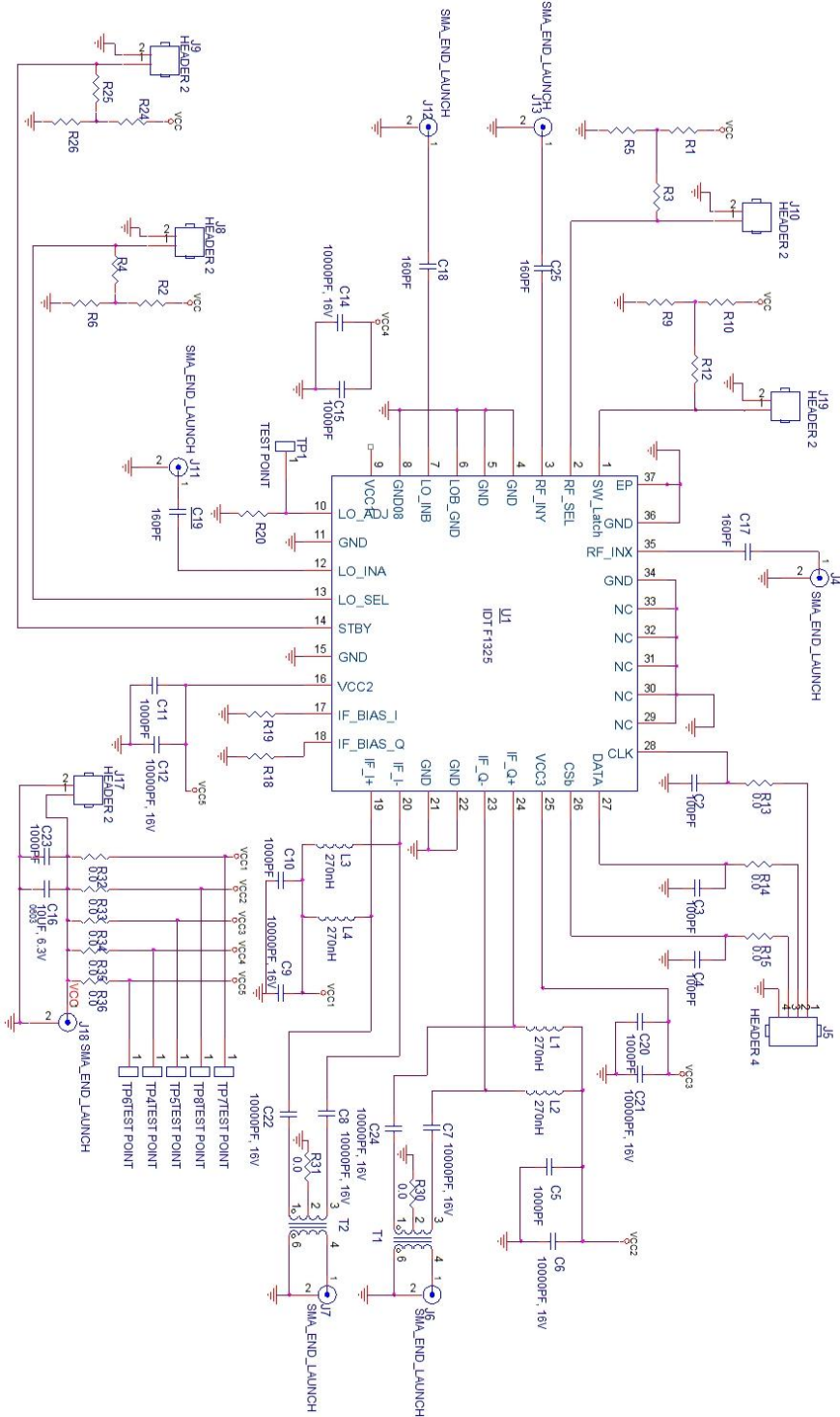



# IDTF1325NBGI Datasheet

DPD Demodulator for PA Linearization

600MHz to 1150MHz

## EVKIT BOMS

F1325 BOM  
6/11/2013

Item #	Value	Size	Desc	Mfr. Part #	Mfr.	Supplier Part #	Supplier	Part Reference	Qty
1	100pF	0402	CAP CER 100PF 50V 5% NP0 0402	GRM1555C1H101JZ01D	MURATA	490-3458-1-ND	Digikey	C2-C4	3
2	10nF	0402	CAP CER 10000PF 16V 10% X7R 0402	GRM155R71C103KA01D	MURATA	490-1313-1-ND	Digikey	C6,7,8,9,12,14,21,22,24	9
3	1000pF	0402	CAP CER 1000PF 50V C0G 0402	GRM1555C1H102JA01D	MURATA	490-3244-1-ND	Digikey	C5,10,11,15,20,23	6
4	160pF	0402	CAP CER 160PF 50V 5% NP0 0402	GRM1555C1H161JA01D	MURATA	490-3230-1-ND	Digikey	C17,18,19,25	4
5	10uF	0603	CAP CER 10UF 6.3V X5R 0603	GRM188R60J106ME47D	MURATA	490-3896-1-ND	Digikey	C16	1
6	Header 2 Pin	TH 2	CONN HEADER VERT SGL 2POS GOLD	961102-6404-AR	3M	3M9447-ND	Digikey	J8,9,10,14,17	5
7	Header 4 Pin	TH 4	CONN HEADER VERT SGL 4POS GOLD	961104-6404-AR	3M	3M9449-ND	Digikey	J5	1
8	SMA_END_LAUNCH	.062	SMA_END_LAUNCH (Small)	142-0711-821	Emerson Johnson	530-142-0711-821	Mouser	J6,7,18	3
9	SMA_END_LAUNCH	.062	SMA_END_LAUNCH (Big)	142-0701-851	Emerson Johnson	530-142-0701-851	Mouser	J4,11,12,13	4
10	1uH	0805	0805LS (2012) Ceramic Chip Inductor	0805LS-102XJLB	COILCRAFT	0805LS-102XJLB	COILCRAFT	L1,2,3,4	4
11	43K	0402	RES 43K OHM 1/10W 1% 0402 SMD	ERJ-2RKF4302X	Panasonic	P43.0KLCT-ND	Digikey	R5,6,9,26	4
12	75K	0402	RES 75K OHM 1/10W 1% 0402 SMD	ERJ-2RKF7502X	Panasonic	P75.0KLCT-ND	Digikey	R1,2,10,24	4
13	2.80K	0402	RES 2.80K OHM 1/10W 1% 0402 SMD	ERJ-2RKF2801X	Panasonic	P2.80KLCT-ND	Digikey	R20	1
14	121	0402	RES 121 OHM 1/10W 1% 0402 SMD	ERJ-2RKF1210X	Panasonic	P121LCT-ND	Digikey	R18,19	2
15	47K	0402	RES 47.0K OHM 1/16W 1% 0402 SMD	RC0402FR-0747KL	Yageo	311-47.0KLRCT-ND	Digikey	R3,4,12,25	4
16	100	0402	RES 100 OHM 1/10W 1% 0402 SMD	ERJ-2RKF1000X	Panasonic	P100LCT-ND	Digikey	R13-15	3
17	0	0402	RES 0.0 OHM 1/10W 0402 SMD	ERJ-2GE0R00X	Panasonic	P0.0JCT-ND	Digikey	R30,31,32,33,34,35,36	7
18	2:1 Balun	SM-22	2:1 Center Tap Balun	TC2-72T+	Mini Circuits	TC2-72T+	Mini Circuits	T1,2	2
19	F1325	QFN-36	DPD Demodulator	F1325	IDT	F1325	IDT	U1	1
20	PCB	Rev 01	Printed Circuit Board	F1375 EV Kit Rev 01			SBC		1
21	BOM	Rev 04	Bill Of Material						

69

Rev 2: Change Balun 4:1 (TC4-6TG2+) to 2:1 (TC2-72T+)

Delete C2-4 (100pF)

Replace R13-15 (0 ohm) to 3K

Rev 3: Replace R1,2,10,24 (43K) to 75K & Replace R5,6,9,26 (75K) to 43K

Rev 4: Replace R13-15 (3K ohm) to 100 ohm, Add C2-C4 100pF

## TOP MARKINGS

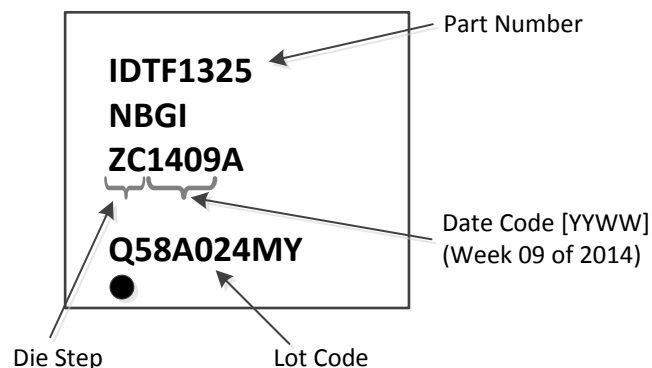

REVISIONS			
REV	DESCRIPTION	DATE	APPROVED
00	INITIAL RELEASE	4/6/16	JH

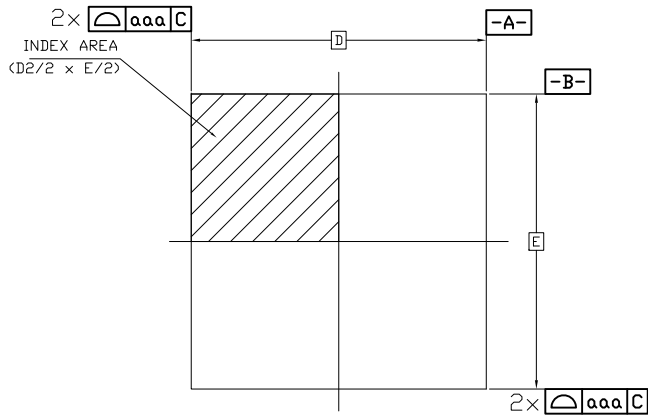

TOP VIEW

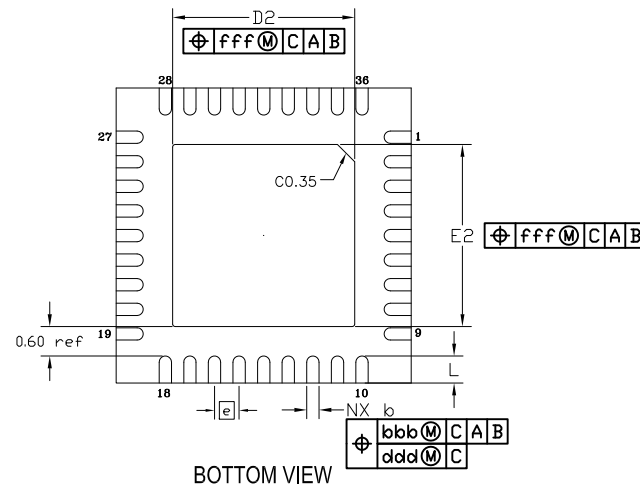

BOTTOM VIEW

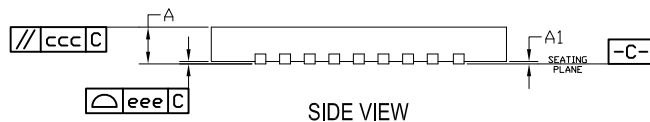

SIDE VIEW

SYMBOL	DIMENSION		
	MIN	NOM	MAX
L	0.45	0.55	0.65
D	6.00 BSC		
E	6.00 BSC		
D2	3.60	3.70	3.80
E2	3.60	3.70	3.80
e	0.50 BSC		
A	0.70	0.75	0.80
A1	0.00	0.02	0.05
b	.20	.25	.30
aaa	0.15		
bbb	0.10		
ccc	0.10		
ddd	0.05		
eee	0.08		
fff	0.10		

NOTES:

1. ALL DIMENSIONING AND TOLERANCING CONFORM TO ANSI Y14.5M-1982
2. ALL DIMENSIONS ARE IN MILLIMETERS.

TOLERANCES  
UNLESS SPECIFIED  
DECIMAL ANGULAR  
X± .1 ±1°  
XX± .05  
XXX± .030



6024 SILVER CREEK  
VALLEY ROAD. SAN JOSE,  
CA 95138  
PHONE: (408) 284-8200  
FAX: (408) 284-3572

APPROVALS DATE  
DRAWN BAC 4/6/16  
CHECKED

TITLE NB/NBG36 PACKAGE OUTLINE  
6.0 x 6.0 mm BODY, EPAD 3.70 mm SQ  
0.50 mm PITCH QFN

SIZE DRAWING No.  
C PSC-4311-01  
DO NOT SCALE DRAWING

REV  
00  
SHEET 1 OF 2

REVISIONS			
REV	DESCRIPTION	DATE	APPROVED
00	INITIAL RELEASE	4/6/16	JH

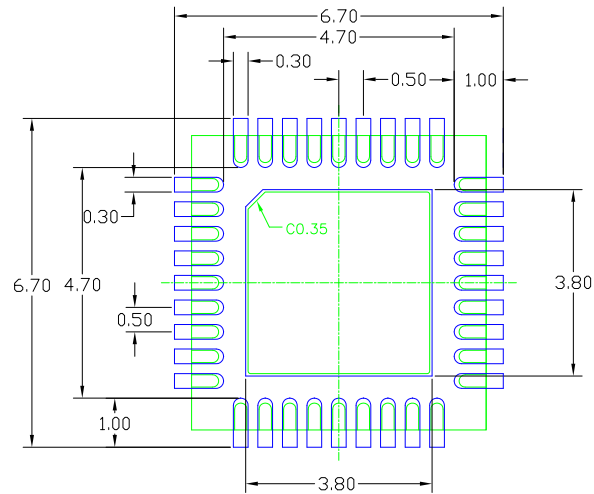

RECOMMENDED LAND PATTERN DIMENSION

NOTES:

1. ALL DIMENSION ARE IN mm. ANGLES IN DEGREES.
2. TOP DOWN VIEW. AS VIEWED ON PCB.
3. COMPONENT OUTLINE SHOW FOR REFERENCE IN GREEN.
4. LAND PATTERN IN BLUE. NSMD PATTERN ASSUMED.
5. LAND PATTERN RECOMMENDATION PER IPC-7351B GENERIC REQUIREMENT FOR SURFACE MOUNT DESIGN AND LAND PATTERN.

TOLERANCES UNLESS SPECIFIED		 www.IDT.com	6024 SILVER CREEK VALLEY ROAD. SAN JOSE, CA 95138 PHONE: (408) 284-8200 FAX: (408) 284-3572	
DECIMAL	ANGULAR			
X± .1	±1°			
XX± .05				
XXX± .030				
APPROVALS	DATE	TITLE NB/NBG36 PACKAGE OUTLINE		
	4/6/16	6.0 x 6.0 mm BODY, EPAD 3.70 mm SQ		
CHECKED		0.50 mm PITCH QFN		
		SIZE	DRAWING No.	REV
		C	PSC-4311-01	00
DO NOT SCALE DRAWING				SHEET 2 OF 2

## IMPORTANT NOTICE AND DISCLAIMER

RENESAS ELECTRONICS CORPORATION AND ITS SUBSIDIARIES (“RENESAS”) PROVIDES TECHNICAL SPECIFICATIONS AND RELIABILITY DATA (INCLUDING DATASHEETS), DESIGN RESOURCES (INCLUDING REFERENCE DESIGNS), APPLICATION OR OTHER DESIGN ADVICE, WEB TOOLS, SAFETY INFORMATION, AND OTHER RESOURCES “AS IS” AND WITH ALL FAULTS, AND DISCLAIMS ALL WARRANTIES, EXPRESS OR IMPLIED, INCLUDING, WITHOUT LIMITATION, ANY IMPLIED WARRANTIES OF MERCHANTABILITY, FITNESS FOR A PARTICULAR PURPOSE, OR NON-INFRINGEMENT OF THIRD PARTY INTELLECTUAL PROPERTY RIGHTS.

These resources are intended for developers skilled in the art designing with Renesas products. You are solely responsible for (1) selecting the appropriate products for your application, (2) designing, validating, and testing your application, and (3) ensuring your application meets applicable standards, and any other safety, security, or other requirements. These resources are subject to change without notice. Renesas grants you permission to use these resources only for development of an application that uses Renesas products. Other reproduction or use of these resources is strictly prohibited. No license is granted to any other Renesas intellectual property or to any third party intellectual property. Renesas disclaims responsibility for, and you will fully indemnify Renesas and its representatives against, any claims, damages, costs, losses, or liabilities arising out of your use of these resources. Renesas' products are provided only subject to Renesas' Terms and Conditions of Sale or other applicable terms agreed to in writing. No use of any Renesas resources expands or otherwise alters any applicable warranties or warranty disclaimers for these products.

(Rev.1.0 Mar 2020)

### Corporate Headquarters

TOYOSU FORESIA, 3-2-24 Toyosu,  
Koto-ku, Tokyo 135-0061, Japan  
[www.renesas.com](http://www.renesas.com)

### Contact Information

For further information on a product, technology, the most up-to-date version of a document, or your nearest sales office, please visit:  
[www.renesas.com/contact/](http://www.renesas.com/contact/)

### Trademarks

Renesas and the Renesas logo are trademarks of Renesas Electronics Corporation. All trademarks and registered trademarks are the property of their respective owners.



# Mouser Electronics

Authorized Distributor

Click to View Pricing, Inventory, Delivery & Lifecycle Information:

[Renesas Electronics:](#)

[F1325NBGI8](#) [F1325NBGI](#) [F1325EVBI](#)