

HFA3102

Dual Long-Tailed Pair Transistor Array

FN3635
Rev.5.00
July 14, 2005

The HFA3102 is an all NPN transistor array configured as dual differential amplifiers with tail transistors. Based on Intersil bonded wafer UHF-1 SOI process, this array achieves very high f_T (10GHz) while maintaining excellent h_{FE} and V_{BE} matching characteristics over temperature. Collector leakage currents are maintained to under 0.01nA.

Ordering Information

PART NUMBER	TEMP. RANGE (°C)	PACKAGE	PKG. DWG. #
HFA3102B96	-40 to 85	14 Ld SOIC Tape and Reel	M14.15
HFA3102BZ (Note)	-40 to 85	14 Ld SOIC (Pb-free)	M14.15
HFA3102BZ96 (Note)	-40 to 85	14 Ld SOIC Tape and Reel (Pb-free)	M14.15

NOTE: Intersil Pb-free plus anneal products employ special Pb-free material sets; molding compounds/die attach materials and 100% matte tin plate termination finish, which are RoHS compliant and compatible with both SnPb and Pb-free soldering operations. Intersil Pb-free products are MSL classified at Pb-free peak reflow temperatures that meet or exceed the Pb-free requirements of IPC/JEDEC J STD-020.

Pinout/Functional Diagram

HFA3102 (SOIC)
TOP VIEW

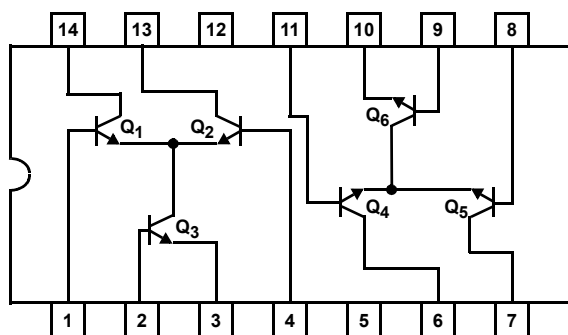

Features

- High Gain-Bandwidth Product (f_T) 10GHz
- High Power Gain-Bandwidth Product. 5GHz
- High Current Gain (h_{FE}) 70
- Noise Figure (Transistor) 3.5dB
- Low Collector Leakage Current <0.01nA
- Excellent h_{FE} and V_{BE} Matching
- Pin-to-Pin to UPA102G
- Pb-Free Plus Anneal Available (RoHS Compliant)

Applications

- Single Balanced Mixers
- Wide Band Amplification Stages
- Differential Amplifiers
- Multipliers
- Automatic Gain Control Circuits
- Frequency Doublers, Triplers
- Oscillators
- Constant Current Sources
- Wireless Communication Systems
- Radio and Satellite Communications
- Fiber Optic Signal Processing
- High Performance Instrumentation

Absolute Maximum Ratings $T_A = 25^\circ\text{C}$

V_{CE0} Collector to Emitter Voltage	8.0V
V_{CBO} Collector to Base Voltage	12.0V
V_{EBO} Emitter to Base Voltage	12.0V
I_C , Collector Current	30mA

Operating Conditions

Temperature Range	-40°C to 85°C
-------------------	---------------

Thermal Information

Thermal Resistance (Typical, Note 1)	θ_{JA} (°C/W)
SOIC Package	128
Maximum Power Dissipation at 75°	
Any One Transistor	0.25W
Maximum Junction Temperature (Die)	175°C
Maximum Junction Temperature (Plastic Package)	150°C
Maximum Storage Temperature Range	-65°C to 150°C
Maximum Lead Temperature (Soldering 10s)	300°C
(SOIC - Lead Tips Only)	

CAUTION: Stresses above those listed in "Absolute Maximum Ratings" may cause permanent damage to the device. This is a stress only rating and operation of the device at these or any other conditions above those indicated in the operational sections of this specification is not implied.

NOTE:

- θ_{JA} is measured with the component mounted on an evaluation PC board in free air.

Electrical Specifications $T_A = 25^\circ\text{C}$

SYMBOLS	PARAMETER	TEST CONDITIONS	(NOTE 2) TEST LEVEL	ALL GRADES			UNITS	
				MIN	TYP	MAX		
$V_{(BR)CBO}$	Collector-to-Base Breakdown Voltage (Q_1 , Q_2 , Q_4 , and Q_5)	$I_C = 100\mu\text{A}$, $I_E = 0$	A	12	18	-	V	
$V_{(BR)CEO}$	Collector-to-Emitter Breakdown Voltage (Q_1 thru Q_6)	$I_C = 100\mu\text{A}$, $I_B = 0$	A	8	12	-	V	
$V_{(BR)EBO}$	Emitter-to-Base Breakdown Voltage (Q_3 and Q_6)	$I_E = 50\mu\text{A}$, $I_C = 0$	A	5.5	6	-	V	
I_{CBO}	Collector Cutoff Current (Q_1 , Q_2 , Q_4 , and Q_5)	$V_{CB} = 5\text{V}$, $I_E = 0$	A	-	0.1	10	μA	
I_{EBO}	Emitter Cutoff Current (Q_3 and Q_6)	$V_{EB} = 1\text{V}$, $I_C = 0$	A	-	-	100	μA	
h_{FE}	DC Current Gain (Q_1 thru Q_6)	$I_C = 10\text{mA}$, $V_{CE} = 3\text{V}$	A	40	70	-	-	
C_{CB}	Collector-to-Base Capacitance	$V_{CB} = 5\text{V}$, $f = 1\text{MHz}$	B	-	300	-	$\overline{\text{fF}}$	
C_{EB}	Emitter-to-Base Capacitance	$V_{EB} = 0$, $f = 1\text{MHz}$	B	-	200	-	$\overline{\text{fF}}$	
f_T	Current Gain-Bandwidth Product	$I_C = 10\text{mA}$, $V_{CE} = 5\text{V}$	C	-	10	-	$\overline{\text{GHz}}$	
f_{MAX}	Power Gain-Bandwidth Product	$I_C = 10\text{mA}$, $V_{CE} = 5\text{V}$	C	-	5	-	GHz	
G_{NFMIN}	Available Gain at Minimum Noise Figure	$I_C = 3\text{mA}$, $V_{CE} = 3\text{V}$	$f = 0.5\text{GHz}$	C	-	17.5	-	dB
			$f = 1.0\text{GHz}$	C	-	12.4	-	dB
NF_{MIN}	Minimum Noise Figure	$I_C = 3\text{mA}$, $V_{CE} = 3\text{V}$	$f = 0.5\text{GHz}$	C	-	1.8	-	dB
			$f = 1.0\text{GHz}$	C	-	2.1	-	dB
$NF_{50\Omega}$	50 Ω Noise Figure	$I_C = 3\text{mA}$, $V_{CE} = 3\text{V}$	$f = 0.5\text{GHz}$	C	-	3.3	-	dB
			$f = 1.0\text{GHz}$	C	-	3.5	-	dB
h_{FE1}/h_{FE2}	DC Current Gain Matching (Q_1 and Q_2 , Q_4 and Q_5)	$I_C = 10\text{mA}$, $V_{CE} = 3\text{V}$	A	0.9	1.0	1.1	-	
V_{OS}	Input Offset Voltage (Q_1 and Q_2 , Q_4 and Q_5)	$I_C = 10\text{mA}$, $V_{CE} = 3\text{V}$	A	-	1.5	5	mV	
I_{OS}	Input Offset Current (Q_1 and Q_2 , Q_4 and Q_5)	$I_C = 10\text{mA}$, $V_{CE} = 3\text{V}$	A	-	5	25	μA	
dV_{OS}/dT	Input Offset Voltage TC (Q_1 and Q_2 , Q_4 and Q_5)	$I_C = 10\text{mA}$, $V_{CE} = 3\text{V}$	C	-	0.5	-	$\mu\text{V}/^\circ\text{C}$	
$I_{TRENCH-LEAKAGE}$	Collector-to-Collector Leakage (Pin 6, 7, 13, and 14)	$\Delta V_{TEST} = 5\text{V}$	B	-	0.01	-	nA	

NOTE:

- Test Level: A. Production Tested; B. Typical or Guaranteed Limit Based on Characterization; C. Design Typical for Information Only

PSICE Model for a Single Transistor

.Model NUHFARRY NPN

+ (IS= 1.840E-16 XTI= 3.000E+00 EG= 1.110E+00
VAF= 7.200E+01+ VAR= 4.500E+00 BF= 1.036E+02 ISE= 1.686E-19
NE= 1.400E+00+ IKF= 5.400E-02 XTB= 0.000E+00 BR= 1.000E+01
ISC= 1.605E-14+ NC= 1.800E+00 IKR= 5.400E-02 RC= 1.140E+01
CJC= 3.980E-13+ MJC= 2.400E-01 VJC= 9.700E-01 FC= 5.000E-01
CJE= 2.400E-13+ MJE= 5.100E-01 VJE= 8.690E-01 TR= 4.000E-09
TF= 10.51E-12+ ITF= 3.500E-02 XTF= 2.300E+00 VTF= 3.500E+00
PTF= 0.000E+00+ XCJC= 9.000E-01 CJS= 1.689E-13 VJS= 9.982E-01
MJS= 0.000E+00+ RE= 1.848E+00 RB= 5.007E+01 RBM= 1.974E+00
KF= 0.000E+00

+ AF= 1.000E+00)

Common Emitter S-Parameters**V_{CE} = 5V and I_C = 5mA**

FREQ. (Hz)	S ₁₁	PHASE(S ₁₁)	S ₁₂	PHASE(S ₁₂)	S ₂₁	PHASE(S ₂₁)	S ₂₂	PHASE(S ₂₂)
1.0E+08	0.833079	-11.7873	1.418901E-02	78.8805	11.0722	168.576	0.976833	-11.0509
2.0E+08	0.791776	-22.8290	2.695740E-02	68.6355	10.5177	157.897	0.930993	-21.3586
3.0E+08	0.734911	-32.6450	3.750029E-02	59.5861	9.75379	148.443	0.868128	-30.4451
4.0E+08	0.672811	-41.0871	4.572138E-02	51.9018	8.91866	140.361	0.799886	-38.1641
5.0E+08	0.612401	-48.2370	5.194147E-02	45.5043	8.10511	133.569	0.734033	-44.5998
6.0E+08	0.557126	-54.2780	5.659943E-02	40.2112	7.35944	127.882	0.674392	-49.9370
7.0E+08	0.508133	-59.4102	6.009507E-02	35.8226	6.69712	123.102	0.622181	-54.3777
8.0E+08	0.465361	-63.8123	6.274213E-02	32.1594	6.11750	119.047	0.577269	-58.1022
9.0E+08	0.428238	-67.6313	6.477134E-02	29.0743	5.61303	115.571	0.538952	-61.2587
1.0E+09	0.396034	-70.9834	6.634791E-02	26.4506	5.17405	112.556	0.506365	-63.9647
1.1E+09	0.368032	-73.9591	6.758932E-02	24.1974	4.79104	109.913	0.478663	-66.3116
1.2E+09	0.343589	-76.6285	6.857937E-02	22.2441	4.45546	107.570	0.455091	-68.3702
1.3E+09	0.322155	-79.0462	6.937837E-02	20.5358	4.15997	105.472	0.435008	-70.1958
1.4E+09	0.303268	-81.2548	7.003020E-02	19.0293	3.89845	103.576	0.417872	-71.8314
1.5E+09	0.286542	-83.2880	7.056718E-02	17.6908	3.66577	101.849	0.403238	-73.3108
1.6E+09	0.271660	-85.1723	7.101343E-02	16.4930	3.45770	100.262	0.390735	-74.6609
1.7E+09	0.258359	-86.9292	7.138717E-02	15.4143	3.27074	98.7956	0.380056	-75.9030
1.8E+09	0.246420	-88.5759	7.170231E-02	14.4370	3.10197	97.4307	0.370947	-77.0544
1.9E+09	0.235659	-90.1265	7.196964E-02	13.5469	2.94897	96.1533	0.363195	-78.1288
2.0E+09	0.225923	-91.5925	7.219757E-02	12.7319	2.80969	94.9515	0.356623	-79.1377
2.1E+09	0.217085	-92.9836	7.239274E-02	11.9824	2.68243	93.8156	0.351081	-80.0903
2.2E+09	0.209034	-94.3076	7.256046E-02	11.2901	2.56573	92.7373	0.346442	-80.9942
2.3E+09	0.201678	-95.5713	7.270498E-02	10.6480	2.45837	91.7097	0.342599	-81.8557
2.4E+09	0.194939	-96.7803	7.282977E-02	10.0503	2.35928	90.7271	0.339458	-82.6802
2.5E+09	0.188747	-97.9395	7.293764E-02	9.49212	2.26756	89.7844	0.336942	-83.4719
2.6E+09	0.183044	-99.0530	7.303093E-02	8.96908	2.18243	88.8775	0.334982	-84.2347
2.7E+09	0.177780	-100.124	7.311157E-02	8.47753	2.10322	88.0026	0.333518	-84.9716
2.8E+09	0.172909	-101.156	7.318117E-02	8.01430	2.02934	87.1565	0.332499	-85.6853
2.9E+09	0.168394	-102.152	7.324107E-02	7.57661	1.96027	86.3366	0.331879	-86.3781
3.0E+09	0.164200	-103.114	7.329243E-02	7.16204	1.89556	85.5404	0.331620	-87.0518

V_{CE} = 5V and I_C = 10mA

FREQ. (Hz)	S ₁₁	PHASE(S ₁₁)	S ₁₂	PHASE(S ₁₂)	S ₂₁	PHASE(S ₂₁)	S ₂₂	PHASE(S ₂₂)
1.0E+08	0.728106	-16.4319	1.273920E-02	75.4177	15.1273	165.227	0.959692	-14.2688
2.0E+08	0.670836	-31.2669	2.342300E-02	62.8941	13.9061	152.045	0.886232	-26.9507
3.0E+08	0.600268	-43.7663	3.132521E-02	52.5891	12.3970	141.185	0.796016	-37.3172
4.0E+08	0.531768	-54.0028	3.681579E-02	44.5019	10.9257	132.570	0.708892	-45.4503
5.0E+08	0.471795	-62.3880	4.057046E-02	38.2308	9.62995	125.781	0.633146	-51.7704
6.0E+08	0.421506	-69.3569	4.316292E-02	33.3405	8.53559	120.378	0.570209	-56.7206
7.0E+08	0.379961	-75.2612	4.499071E-02	29.4764	7.62375	116.005	0.518803	-60.6598
8.0E+08	0.345693	-80.3608	4.631140E-02	26.3755	6.86423	112.398	0.476987	-63.8540
9.0E+08	0.317301	-84.8420	4.728948E-02	23.8481	6.22797	109.365	0.442915	-66.4948
1.0E+09	0.293608	-88.8381	4.803091E-02	21.7581	5.69057	106.771	0.415044	-68.7193
1.1E+09	0.273680	-92.4452	4.860515E-02	20.0070	5.23257	104.518	0.392146	-70.6269
1.2E+09	0.256782	-95.7336	4.905871E-02	18.5224	4.83873	102.532	0.373261	-72.2899
1.3E+09	0.242344	-98.7555	4.942344E-02	17.2505	4.49716	100.759	0.357640	-73.7620
1.4E+09	0.229918	-101.551	4.972158E-02	16.1506	4.19854	99.1602	0.344698	-75.0832
1.5E+09	0.219152	-104.150	4.996903E-02	15.1915	3.93554	97.7028	0.333974	-76.2840
1.6E+09	0.209767	-106.577	5.017730E-02	14.3490	3.70234	96.3629	0.325102	-77.3877
1.7E+09	0.201539	-108.851	5.035491E-02	13.6040	3.49428	95.1215	0.317789	-78.4122
1.8E+09	0.194288	-110.988	5.050825E-02	12.9411	3.30758	93.9633	0.311800	-79.3715
1.9E+09	0.187867	-113.001	5.064218E-02	12.3482	3.13919	92.8761	0.306940	-80.2768
2.0E+09	0.182157	-114.902	5.076045E-02	11.8151	2.98658	91.8500	0.303051	-81.1365
2.1E+09	0.177056	-116.698	5.086598E-02	11.3338	2.84766	90.8766	0.300003	-81.9578
2.2E+09	0.172484	-118.399	5.096107E-02	10.8974	2.72068	89.9494	0.297686	-82.7460
2.3E+09	0.168370	-120.012	5.104755E-02	10.5001	2.60420	89.0626	0.296007	-83.5057
2.4E+09	0.164656	-121.542	5.112690E-02	10.1373	2.49697	88.2115	0.294889	-84.2405
2.5E+09	0.161293	-122.996	5.120031E-02	9.80479	2.39793	87.3920	0.294266	-84.9533
2.6E+09	0.158239	-124.378	5.126876E-02	9.49919	2.30619	86.6007	0.294081	-85.6466
2.7E+09	0.155458	-125.694	5.133304E-02	9.21750	2.22098	85.8348	0.294285	-86.3223
2.8E+09	0.152919	-126.947	5.139381E-02	8.95716	2.14162	85.0916	0.294836	-86.9822
2.9E+09	0.150595	-128.140	5.145164E-02	8.71595	2.06753	84.3690	0.295696	-87.6275
3.0E+09	0.148463	-129.279	5.150697E-02	8.49194	1.99820	83.6651	0.296834	-88.2595

Typical Performance Curves

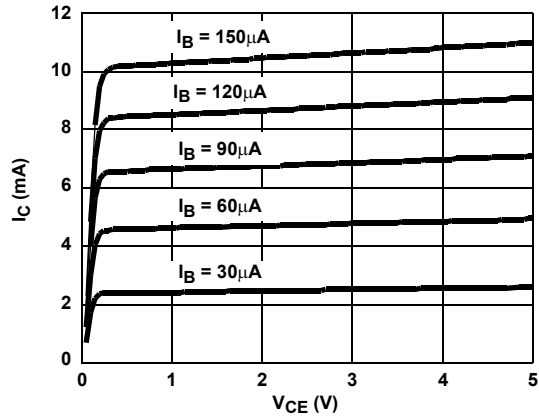

FIGURE 1. I_C vs V_{CE}

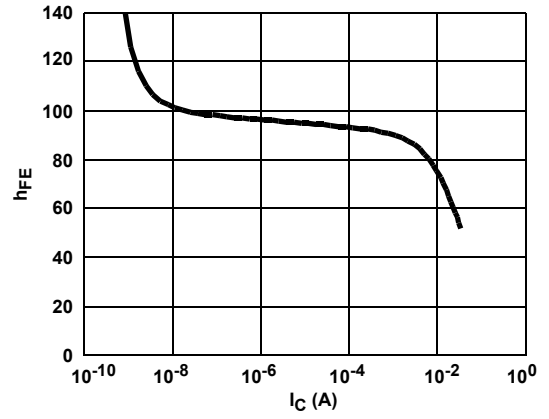

FIGURE 2. h_{FE} vs I_C

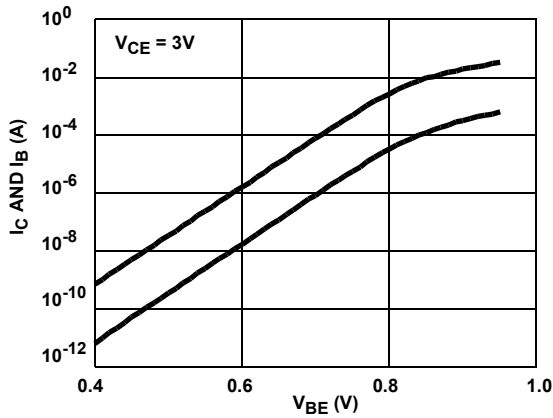

FIGURE 3. GUMMEL PLOT

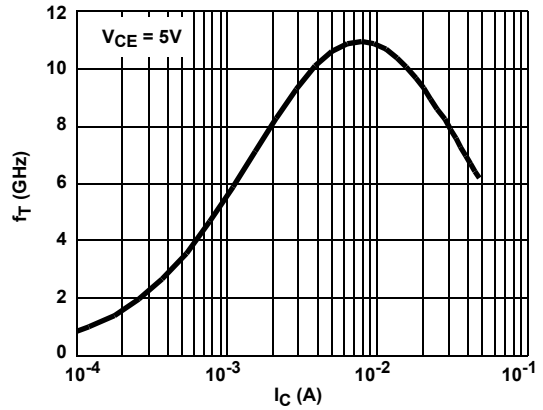

FIGURE 4. f_T vs I_C

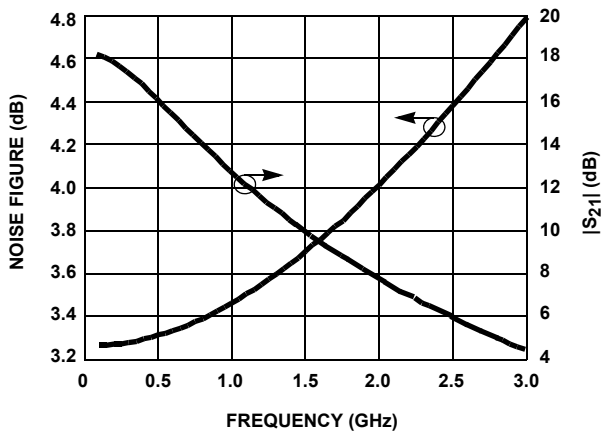

FIGURE 5. GAIN AND NOISE FIGURE vs FREQUENCY

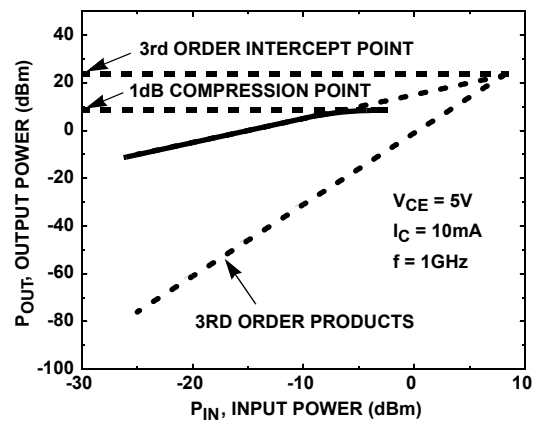

FIGURE 6. P_{1dB} AND 3RD ORDER INTERCEPT

Die Characteristics

PROCESS:

UHF-1

DIE DIMENSIONS:

53 mils x 52 mils x 14 mils
 1340µm x 1320µm x 355.6µm

METALLIZATION:

Type: Metal 1: AlCu(2%)/TiW
 Thickness: Metal 1: 8kÅ ±0.5kÅ
 Type: Metal 2: AlCu(2%)
 Thickness: Metal 2: 16kÅ ±0.8kÅ

PASSIVATION:

Type: Nitride
 Thickness: 4kÅ ±0.5kÅ

SUBSTRATE POTENTIAL (POWERED UP):

Floating

Metallization Mask Layout

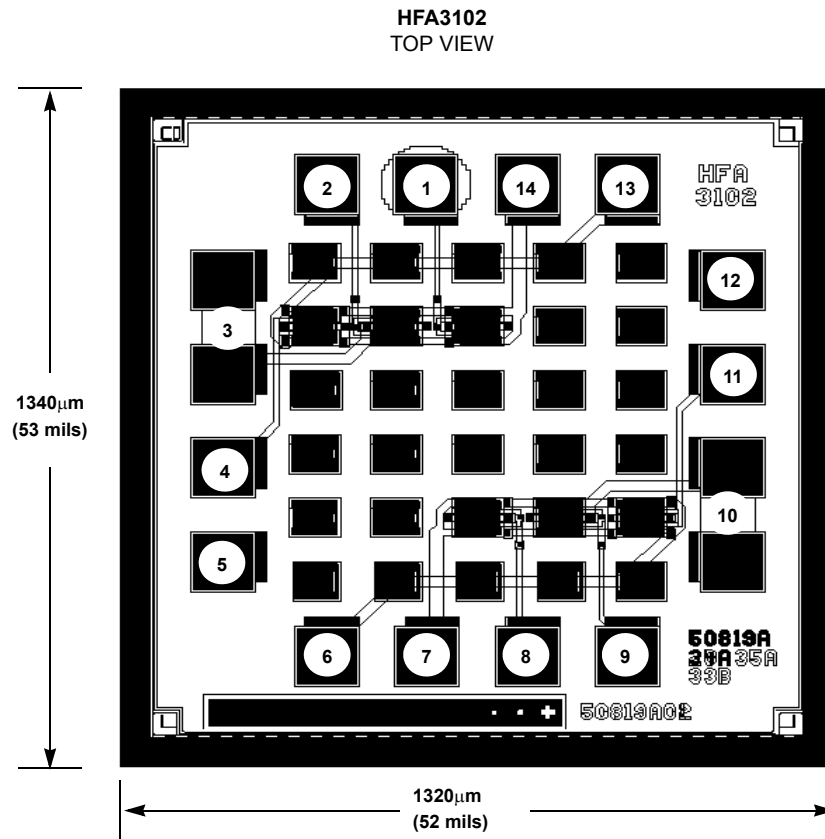

Pad numbers correspond to the 14 pin SOIC pinout.

Small Outline Plastic Packages (SOIC)

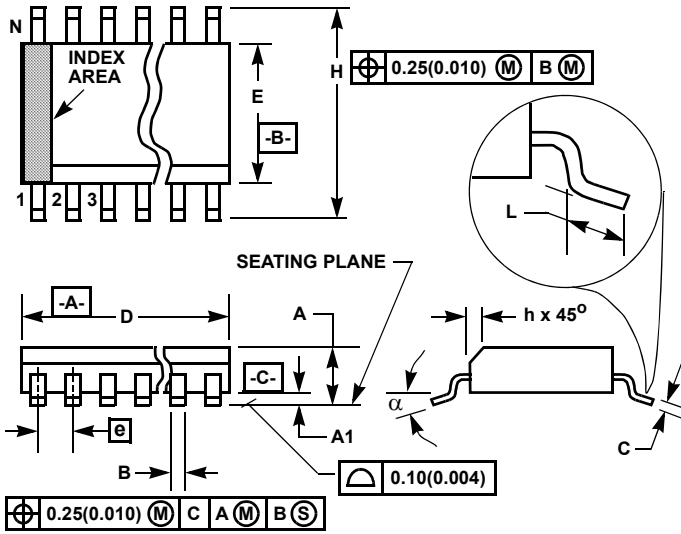

**M14.15 (JEDEC MS-012-AB ISSUE C)
14 LEAD NARROW BODY SMALL OUTLINE PLASTIC PACKAGE**

SYMBOL	INCHES		MILLIMETERS		NOTES
	MIN	MAX	MIN	MAX	
A	0.0532	0.0688	1.35	1.75	-
A1	0.0040	0.0098	0.10	0.25	-
B	0.013	0.020	0.33	0.51	9
C	0.0075	0.0098	0.19	0.25	-
D	0.3367	0.3444	8.55	8.75	3
E	0.1497	0.1574	3.80	4.00	4
e	0.050 BSC		1.27 BSC		-
H	0.2284	0.2440	5.80	6.20	-
h	0.0099	0.0196	0.25	0.50	5
L	0.016	0.050	0.40	1.27	6
N	14		14		7
alpha	0°	8°	0°	8°	-

NOTES:

1. Symbols are defined in the "MO Series Symbol List" in Section 2.2 of Publication Number 95.
2. Dimensioning and tolerancing per ANSI Y14.5M-1982.
3. Dimension "D" does not include mold flash, protrusions or gate burrs. Mold flash, protrusion and gate burrs shall not exceed 0.15mm (0.006 inch) per side.
4. Dimension "E" does not include interlead flash or protrusions. Interlead flash and protrusions shall not exceed 0.25mm (0.010 inch) per side.
5. The chamfer on the body is optional. If it is not present, a visual index feature must be located within the crosshatched area.
6. "L" is the length of terminal for soldering to a substrate.
7. "N" is the number of terminal positions.
8. Terminal numbers are shown for reference only.
9. The lead width "B", as measured 0.36mm (0.014 inch) or greater above the seating plane, shall not exceed a maximum value of 0.61mm (0.024 inch).
10. Controlling dimension: MILLIMETER. Converted inch dimensions are not necessarily exact.

Rev. 0 12/93

© Copyright Intersil Americas LLC 2003-2005. All Rights Reserved.
All trademarks and registered trademarks are the property of their respective owners.

For additional products, see www.intersil.com/en/products.html

Intersil products are manufactured, assembled and tested utilizing ISO9001 quality systems as noted in the quality certifications found at www.intersil.com/en/support/qualandreliability.html

Intersil products are sold by description only. Intersil may modify the circuit design and/or specifications of products at any time without notice, provided that such modification does not, in Intersil's sole judgment, affect the form, fit or function of the product. Accordingly, the reader is cautioned to verify that datasheets are current before placing orders. Information furnished by Intersil is believed to be accurate and reliable. However, no responsibility is assumed by Intersil or its subsidiaries for its use; nor for any infringements of patents or other rights of third parties which may result from its use. No license is granted by implication or otherwise under any patent or patent rights of Intersil or its subsidiaries.

For information regarding Intersil Corporation and its products, see www.intersil.com

Mouser Electronics

Authorized Distributor

Click to View Pricing, Inventory, Delivery & Lifecycle Information:

[Renesas Electronics:](#)

[HFA3102BZ](#) [HFA3102BZ96](#)