

FIGURE 2. SIMPLIFIED SCHEMATIC (for 14 LD SOIC)

Ordering Information

PART NUMBER (Notes 2, 3)	PART MARKING	TEMP. RANGE (°C)	TAPE AND REEL (Units) (Note 1)	PACKAGE (RoHS Compliant)	PKG. DWG. #
ISL6161IVZA-T	6161IVZ	-40 to +85	2.5k	16 Ld TSSOP	M16.173
ISL6161CBZA	6161CBZ	0 to +70	-	14 Ld SOIC	M14.15
ISL6161CBZA-T	6161CBZ	0 to +70	2.5k	14 Ld SOIC	M14.15

NOTE:

1. Refer to [TB347](#) for details about reel specifications.
2. These Pb-free plastic packaged products employ special Pb-free material sets, molding compounds/die attach materials, and 100% matte tin plate plus anneal (e3 termination finish, which is RoHS compliant and compatible with both SnPb and Pb-free soldering operations). Pb-free products are MSL classified at Pb-free peak reflow temperatures that meet or exceed the Pb-free requirements of IPC/JEDEC J STD-020.
3. For Moisture Sensitivity Level (MSL), see the [ISL6161](#) product information. For more information about MSL, refer to [TB363](#).

Pin Configurations

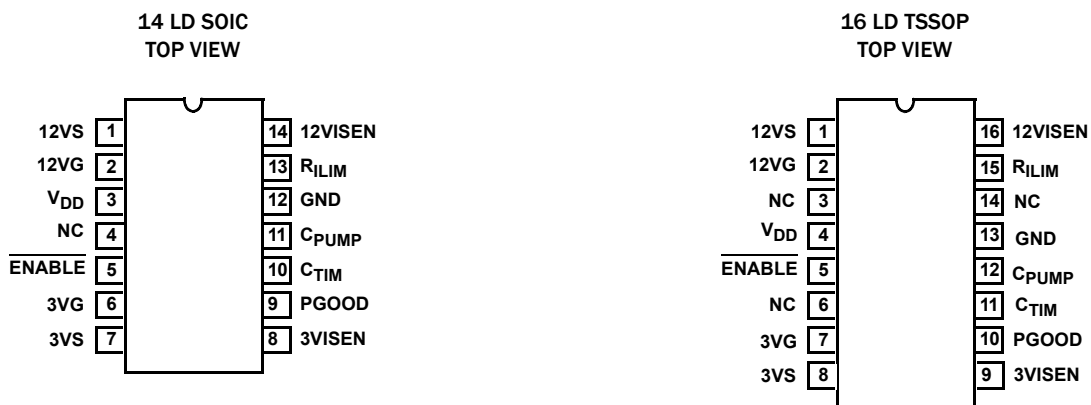

Pin Descriptions

PIN # SOIC	PIN # TSSOP	SYMBOL	FUNCTION	DESCRIPTION
1	1	12VS	12V Source	Connect to the associated external N-channel MOSFET switch source to sense output voltage.
2	2	12VG	12V Gate	Connect to the associated N-channel MOSFET switch gate. A capacitor from this node to ground sets the turn-on ramp. At turn-on, this capacitor will be charged to ~17.4V by a 10µA current source.
3	4	V _{DD}	Chip Supply	Connect to the 12V supply. This can be connected directly to the +12V rail supplying the load voltage or to a dedicated V _{DD} +12V supply. If connecting to the +12V rail supplying the load voltage, pay special attention to V _{DD} decoupling to prevent sagging as heavy loads are switched on.
4	3,6,14	NC	Not Connected	Not connected.
5	5	$\overline{\text{ENABLE}}$	Enable/Reset	Turns on and resets the chip. Both outputs turn on when this pin is driven low. After a current limit timeout, the chip is reset by the rising edge of a reset signal applied to the $\overline{\text{ENABLE}}$ pin. This input has 100µA pull-up capability, which is compatible with 3V and 5V open drain and standard logic.
6	7	3VG	3V Gate	Connect to the gate of the external 3V N-channel MOSFET. A capacitor from this node to ground sets the turn-on ramp. At turn-on, this capacitor will be charged to ~11.9V by a 10µA current source.
7	8	3VS	3V Source	Connect to the source side of 3V external N-channel MOSFET switch to sense output voltage.
8	9	3VISEN	3V Current Sense	Connect to the load side of the 3V sense resistor to measure the voltage drop across this resistor between the 3VS and 3VISEN pins.
9	10	PGOOD	Power-Good Indicator	Indicates that all output voltages are within specification. PGOOD is driven by an open drain N-Channel MOSFET. It is pulled low when any output is not within specification.
10	11	C _{TIM}	Current Limit Timing Capacitor	Connect a capacitor from this pin to ground. This capacitor controls the time between the onset of current limit and chip shutdown (current limit timeout). The duration of current limit timeout (in seconds) = 200kΩ × C _{TIM} (Farads).
11	12	C _{PUMP}	Charge Pump Capacitor	Connect a 0.1µF capacitor between this pin and V _{DD} (Pin 3). Provides charge storage for the 12VG drive.
12	13	GND	Chip Ground	Chip ground.
13	15	R _{LIM}	Current Limit Set Resistor	A resistor connected between this pin and ground determines the current level at which current limit is activated. This current is determined by the ratio of the R _{LIM} resistor to the sense resistor (R _{SENSE}). The current at current limit onset is equal to 10µA × (R _{LIM} /R _{SENSE}). The ISL6161 can accommodate either a 10kΩ resistor (OC V _{th} = 100mV) or a 4.99kΩ resistor for a lower trip (OC V _{th} = 53mV). See Table 2 on page 7 for more details.
14	16	12VISEN	12V Current Sense	Connect to the load side of the sense resistor to measure the voltage drop across this resistor.

Absolute Maximum Ratings $T_A = 25^\circ\text{C}$

V_{DD}	-0.3V to +16V
12VG, C_{PUMP}	-0.3V to 21V
12VISEN, 12VS.....	-5V to $V_{DD} + 0.3V$
3VISEN, 3VS.....	-5V to 7.5V
PGOOD, R_{ILIM}	-0.3V to 7.5V
ENABLE, C_{TIM} , 3VG.....	-0.3V to $V_{DD} + 0.3V$
ESD Classification.....	2kV (Class 2)

Thermal Information

Thermal Resistance (Typical, Note 4)	θ_{JA} ($^\circ\text{C}/\text{W}$)
14 Ld SOIC Package	67
16 Ld TSSOP Package.....	94
Maximum Junction Temperature (Plastic Package)	+150 $^\circ\text{C}$
Maximum Storage Temperature Range	-65 $^\circ\text{C}$ to +150 $^\circ\text{C}$
Pb-Free Reflow Profile	Refer to TB493

Operating Conditions

V_{DD} Supply Voltage Range	+10.5V to +13.2V
Temperature Range (T_A)	
ISL6161VZA	-40 $^\circ\text{C}$ to +85 $^\circ\text{C}$
ISL6161CBZA	0 $^\circ\text{C}$ to +70 $^\circ\text{C}$

CAUTION: Do not operate at or near the maximum ratings listed for extended periods of time. Exposure to such conditions may adversely impact product reliability and result in failures not covered by warranty.

NOTES:

- θ_{JA} is measured with the component mounted on a high-effective thermal conductivity test board in free air. Refer to [TB379](#) for details.
- All voltages are relative to GND, unless otherwise specified.

Electrical Specifications $V_{DD} = 12V$, $C_{VG} = 0.01\mu\text{F}$, $C_{TIM} = 0.1\mu\text{F}$, $R_{SENSE} = 0.1\Omega$, $C_{BULK} = 220\mu\text{F}$, $ESR = 0.5W$, $T_A = T_J = -40^\circ\text{C}$ to +85 $^\circ\text{C}$, unless otherwise specified. Parameters with MIN and/or MAX limits are 100% tested at +25 $^\circ\text{C}$, unless otherwise specified. Temperature limits established by characterization and are not production tested.

PARAMETER	SYMBOL	TEST CONDITIONS	MIN	TYP	MAX	UNITS
12V CONTROL						
Current Limit Threshold Voltage (Voltage Across Sense Resistor)	V_{IL12V}	$R_{ILIM} = 10k\Omega$	92	100	108	mV
		$R_{ILIM} = 5k\Omega$	47	53	59	mV
3x Current Limit Threshold Voltage (Voltage Across Sense Resistor)	3 x V_{IL12V}	$R_{ILIM} = 10k\Omega$	250	300	350	mV
		$R_{ILIM} = 5k\Omega$	100	165	210	mV
$\pm 20\%$ Current Limit Response Time (Current within 20% of Regulated Value)	20%iLrt	200% Current Overload, $R_{ILIM} = 10k\Omega$, $R_{SHORT} = 6.0\Omega$	-	2	-	μs
$\pm 10\%$ Current Limit Response Time (Current within 10% of Regulated Value)	10%iLrt	200% Current Overload, $R_{ILIM} = 10k\Omega$, $R_{SHORT} = 6.0\Omega$	-	4	-	μs
$\pm 1\%$ Current Limit Response Time (Current within 1% of Regulated Value)	1%iLrt	200% Current Overload, $R_{ILIM} = 10k\Omega$, $R_{SHORT} = 6.0\Omega$	-	10	-	μs
Response Time to Dead Short	RT_{SHORT}	$C_{12VG} = 0.01\mu\text{F}$	-	500	-	ns
Gate Turn-On Time	t_{ON12V}	$C_{12VG} = 0.01\mu\text{F}$	-	12	-	ms
Gate Turn-On Current	I_{ON12V}	$C_{12VG} = 0.01\mu\text{F}$	8	10	12	μA
3x Gate Discharge Current	3Xdisl	12VG = 18V	-	0.75	-	A
12V Undervoltage Threshold	12V V_{UV}		10.5	10.8	11.0	V
Charge Pumped 12VG Voltage	V12VG	$C_{PUMP} = 0.1\mu\text{F}$	16.8	17.3	17.9	V
3.3V CONTROL						
Current Limit Threshold Voltage (Voltage Across Sense Resistor)	V_{IL3V}	$R_{ILIM} = 10k\Omega$	92	100	108	mV
		$R_{ILIM} = 5k\Omega$	47	53	59	mV
3x Current Limit Threshold Voltage (Voltage Across Sense Resistor)	3 x V_{IL3V}	$R_{ILIM} = 10k\Omega$	250	300	350	mV
		$R_{ILIM} = 5k\Omega$	100	155	210	mV
$\pm 20\%$ Current Limit Response Time (Current within 20% of Regulated Value)		200% Current Overload, $R_{ILIM} = 10k\Omega$, $R_{SHORT} = 2.5\Omega$	-	2	-	μs
$\pm 10\%$ Current Limit Response Time (Current within 10% of Regulated Value)		200% Current Overload, $R_{ILIM} = 10k\Omega$, $R_{SHORT} = 2.5\Omega$	-	4	-	μs

Electrical Specifications $V_{DD} = 12V$, $C_{VG} = 0.01\mu F$, $C_{TIM} = 0.1\mu F$, $R_{SENSE} = 0.1\Omega$, $C_{BULK} = 220\mu F$, $ESR = 0.5W$, $T_A = T_J = -40^\circ C$ to $+85^\circ C$, unless otherwise specified. Parameters with MIN and/or MAX limits are 100% tested at $+25^\circ C$, unless otherwise specified. Temperature limits established by characterization and are not production tested. (Continued)

PARAMETER	SYMBOL	TEST CONDITIONS	MIN	TYP	MAX	UNITS
$\pm 1\%$ Current Limit Response Time (Current within 1% of Regulated Value)		200% Current Overload, $R_{ILIM} = 10k\Omega$, $R_{SHORT} = 2.5\Omega$	-	10	-	μs
Response Time To Dead Short	RT_{SHORT}	$C_{VG} = 0.01\mu F$	-	500		ns
Gate Turn-On Time	t_{ON3V}	$C_{VG} = 0.01\mu F$	-	5	-	ms
Gate Turn-On Current	I_{ON3V}	$C_{VG} = 0.01\mu F$	8	10	12	μA
3x Gate Discharge Current	3xdisl	$C_{VG} = 0.01\mu F$, ENABLE = Low		0.75	-	A
3.3V Undervoltage Threshold	3.3V _{VUV}		2.7	2.85	3.0	V
3.3VG High Voltage	3VG		11.2	11.9	-	V
SUPPLY CURRENT AND IO SPECIFICATIONS						
V_{DD} Supply Current	I_{VDD}		4	8	10	mA
V_{DD} POR Rising Threshold			9.5	10.0	10.7	V
V_{DD} POR Falling Threshold			9.0	9.4	9.8	V
Current Limit Timeout	t_{ILIM}	$C_{TIM} = 0.1\mu F$	-	20	-	ms
ENABLE Pull-Up Voltage	PWRN_V	ENABLE Pin Open	1.8	2.4	3.2	V
ENABLE Rising Threshold	PWR_Vth		1.1	1.5	2	V
ENABLE Hysteresis	PWR_hys		0.1	0.2	0.3	V
ENABLE Pull-Up Current	PWRN_I		60	80	100	μA
Current Limit Timeout Threshold (C_{TIM})	C_{TIM_Vth}		1.8	2	2.2	V
C_{TIM} Charging Current	C_{TIM_I}		8	10	12	μA
C_{TIM} Discharge Current	C_{TIM_disl}		1.7	2.6	3.5	mA
C_{TIM} Pull-Up Current	C_{TIM_disl}	$V_{CTIM} = 8V$	3.5	5	6.5	mA
R_{ILIM} Pin Current Source Output	R_{ILIM_Io}		90	100	110	μA
Charge Pump Output Current	Qpmp_Io	$C_{PUMP} = 0.1\mu F$, $C_{PUMP} = 16V$	320	560	900	μA
Charge Pump Output Voltage	Qpmp_Vo	No Load	17.2	17.4	-	V
Charge Pump Output Voltage - Loaded	Qpmp_VIo	Load Current = 100 μA	16.2	16.7	-	V
Charge Pump POR Rising Threshold	Qpmp + Vth		15.6	16	16.5	V
Charge Pump POR Falling Threshold	Qpmp - Vth		15.2	15.7	16.2	V

ISL6161 Description and Operation

The ISL6161 is a multi-featured +12V and +3.3V dual power supply distribution controller. Its features include programmable Current Regulation (CR) limiting and time to latch off.

At turn-on, the gate capacitor of each external N-channel MOSFET is charged with a 10 μA current source. These capacitors create a programmable ramp (soft turn-on). A charge pump supplies the gate drive for the 12V supply control FET switch, driving that gate to 17V.

The load currents pass through two external current sense resistors. When the voltage across either resistor quickly exceeds the user programmed Current Regulation Voltage Threshold (CRVth) level, the controller enters current regulation. The CRVth is set by the external resistor value on the R_{ILIM} pin. At this time, the timeout

capacitor, C_{TIM} , starts charging with a 10 μA current source and the controller enters the timeout period. The timeout period length is set by the single external capacitor (see [Table 1 on page 7](#)) placed from the C_{TIM} pin (Pin 10) to ground and is characterized by a lowered gate drive voltage to the appropriate external N-channel MOSFET. When C_{TIM} charges to 2V, an internal comparator is tripped, and both N-channel MOSFETs are latched off. If the voltage across the sense resistors rises slowly in response to an OC condition, CR mode is entered at ~95% of the programmed CR level. This is due to the necessary hysteresis and response time in the CR control circuitry.

TABLE 1. C_{TIM} RECOMMENDATIONS

C _{TIM} CAPACITOR (μF)	NOMINAL TIME-OUT PERIOD (ms)
0.022	4.4
0.047	9.4
0.1	20

NOTE:

6. Nominal time-out period in seconds = C_{TIM} x 200kΩ.

Table 2 shows R_{SENSE} and R_{LIM} recommendations and the resulting CR level for the specified PCIe add-in card connector sizes. First select an R_{LIM} value for the appropriate CRV_{th}, then choose the R_{SENSE} value for the desired OC trip. Other applications can select either 4.99kΩ or 10kΩ for R_{LIM}; the accuracy of the CRV_{th} is measured for both. Values below 4.99kΩ are not recommended due to possible noise sensitivity. Values between 4.99kΩ and 10kΩ can be used, but are not measured for accuracy.

TABLE 2. R_{SENSE} AND R_{LIM} RECOMMENDATIONS

PCIe ADD-IN CARD CONNECTOR	R _{LIM} (kΩ)	3.3V R _{SENSE} (mΩ), NOMINAL CR (A)	12V R _{SENSE} (mΩ), NOMINAL CR (A)	NOMINAL CRV _{th} (mV)
X1	10	30, 3.3	150, 0.7	100
	4.99	15, 3.5	90, 0.6	53
X4/X8	10	30, 3.3	40, 2.5	100
	4.99	15, 3.5	20, 2.6	53
X16	10	30, 3.3	16, 6.3	100
	4.99	15, 3.5	8, 6.6	53

NOTE:

7. Nominal CR V_{th} = R_{LIM} x 10μA = OC x R_{SENSE}

The ISL6161 responds to a load short (defined as a current level three times the OC set point with a fast transition) by immediately driving the relevant N-channel MOSFET gate to 0V in ~3μs. The gate voltage is then slowly ramped up, soft-starting the N-channel MOSFET to the programmed current regulation limit level. This is the start of the timeout period if the abnormal load condition still exists. The programmed current regulation level is held until either the OC event ends or the timeout period expires. If the OC event ends, the N-channel MOSFET is fully enhanced and the C_{TIM} charging current is diverted away from the capacitor. If the timeout period expires before the OC event ends, then both gates are quickly pulled to 0V, turning off both N-Channel MOSFETs simultaneously.

Upon any UV condition, the PGOOD signal will pull low when tied high through a resistor to the logic supply. This pin is a fault indicator, but is not the OC latch-off indicator. For an OC latch-off indication, monitor C_{TIM} (Pin 10). This pin will rise rapidly to 12V when the timeout period expires. See [Figure 2 on page 2](#) for an OC latch-off circuit suggestion.

The ISL6161 is reset by a rising edge on the $\overline{\text{ENABLE}}$ pin and is turned on by the $\overline{\text{ENABLE}}$ pin being driven low.

Application Considerations

In a non PCIe, motor drive application, **current loop stabilization** is facilitated through a small value resistor in series with the gate timing capacitor. As the ISL6161 drives a highly inductive current load, instability characterized by the gate voltage repeatedly ramping up and down may occur. Stability can be easily enhanced by substituting a larger gate resistor. Improve stability by eliminating long point-to-point wiring to the load.

The $\overline{\text{ENABLE}}$ internal pull-up makes the ISL6161 well suited for implementation on either side of the connector in which a motherboard prebiased condition or a load board staggered connection is present. In either case, the ISL6161 turns on in Soft-Start mode, protecting the supply rail from sudden current loading.

During the **timeout delay period** with the ISL6161 in current limit mode, the V_{GS} of the external N-channel MOSFETs is reduced, driving the N-channel MOSFET switch into a high r_{DS(ON)} state. Thus, avoid extended timeout periods, because the external N-Channel MOSFETs may be damaged or destroyed due to excessive internal power dissipation. Refer to the MOSFET manufacturer's datasheet for SOA information.

With the high levels of inrush current (highly capacitive loads and motor start-up currents), **choosing the current regulation (CR) level** is crucial to provide both protection and still allow for this inrush current without latching off. Consider this in addition to the timeout delay when choosing MOSFETs for your design.

Physical layout of the R_{SENSE} resistors is critical to avoid inadvertently lowering the CR and trip levels. Ideally, trace routing between the R_{SENSE} resistors and the ISL6161 should be as direct and as short as possible with zero current in the sense lines.

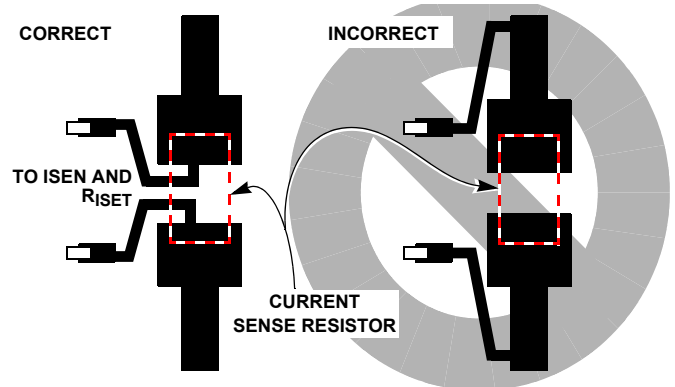

FIGURE 3. SENSE RESISTOR PCB LAYOUT

Monitor the xISEN pins to **detect open loads**. Although gated off, the external FET I_{DSS} will cause the xISEN pins to float above ground to some voltage when no load is attached. If this is not desired, 5k resistors from the xISEN pins to ground will prevent the outputs from floating when the external switch FETs are disabled and the outputs are open.

For PCIe applications, the ISL6161 and the ISL6118 provide the fundamental hotswap function for the +12V and +3.3V main rails and the +3.3V auxiliary rails, respectively, as shown in [“PCI Express Implementation” on page 10](#).

Typical Performance Curves

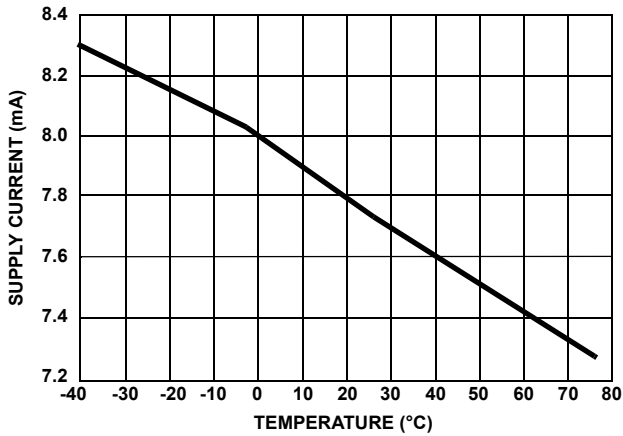

FIGURE 4. SUPPLY CURRENT

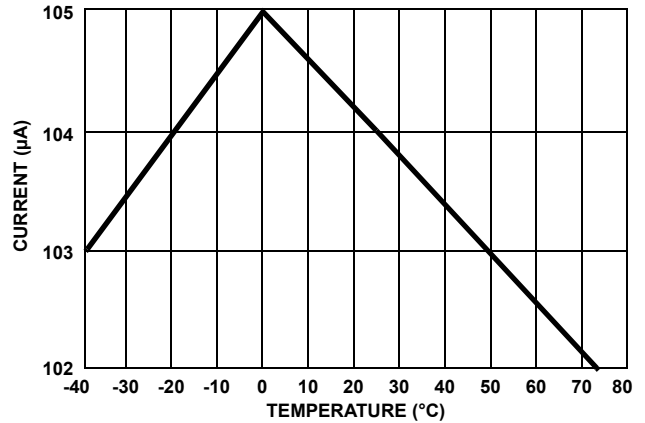

FIGURE 5. R_{ILIM} SOURCE CURRENT

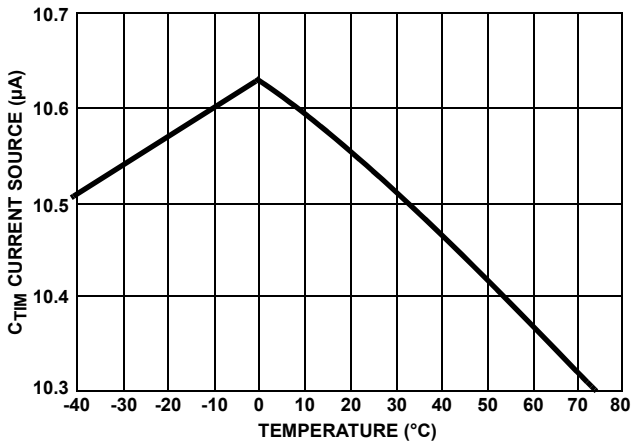

FIGURE 6. C_{TIM} CURRENT SOURCE

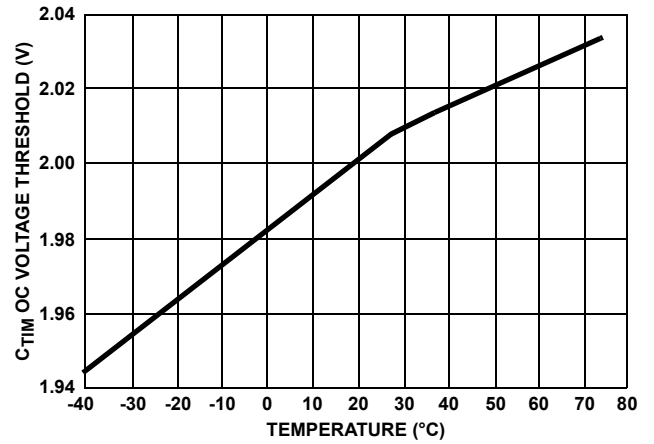

FIGURE 7. C_{TIM} OC VOLTAGE THRESHOLD

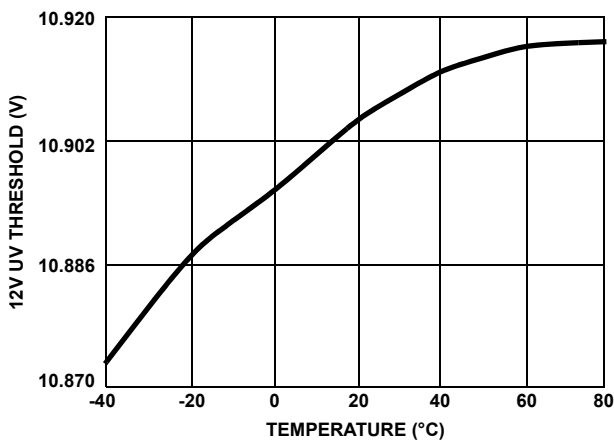

FIGURE 8. 12V UV THRESHOLD

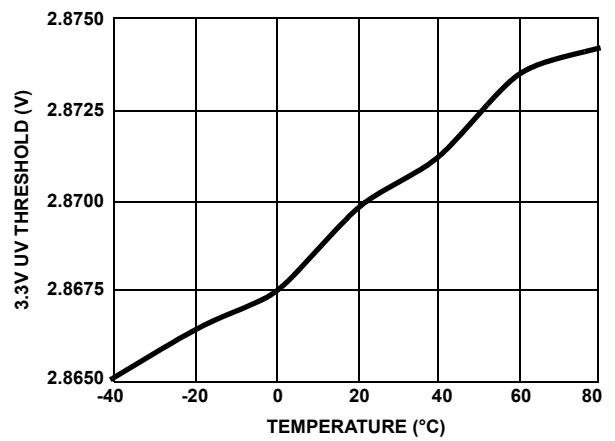

FIGURE 9. 3.3V UV THRESHOLD

Typical Performance Curves (Continued)

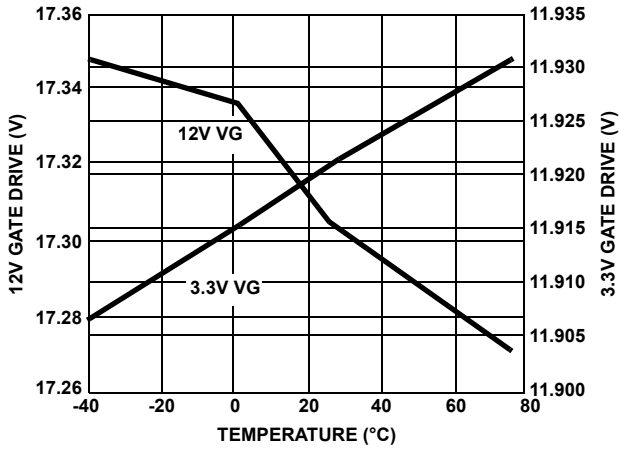

FIGURE 10. 12V, 3.3V GATE DRIVE

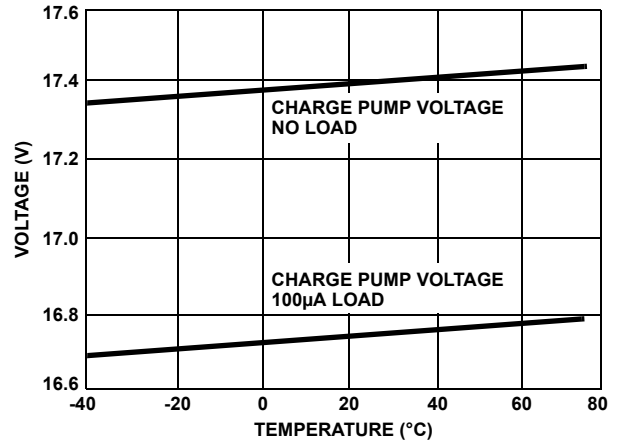

FIGURE 11. PUMP VOLTAGE

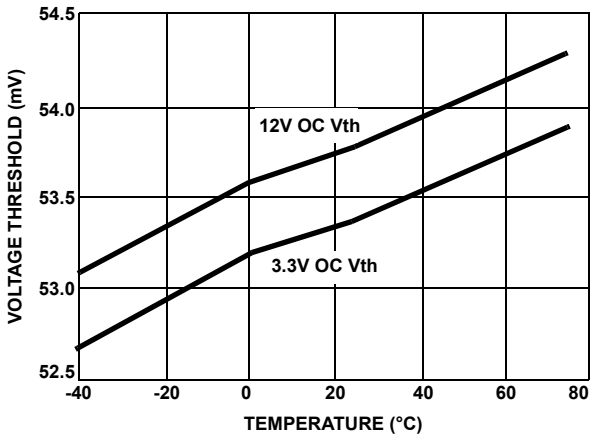

FIGURE 12. OC VOLTAGE THRESHOLD WITH $R_{LIM} = 5k\Omega$

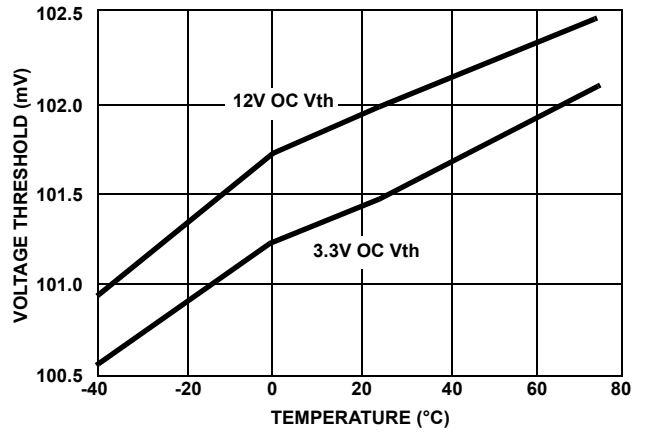

FIGURE 13. OC VOLTAGE THRESHOLD WITH $R_{LIM} = 10k\Omega$

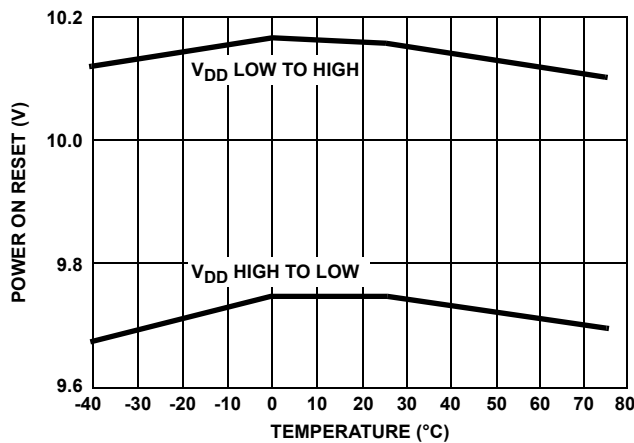

FIGURE 14. POWER-ON RESET VOLTAGE THRESHOLD

PCI Express Implementation

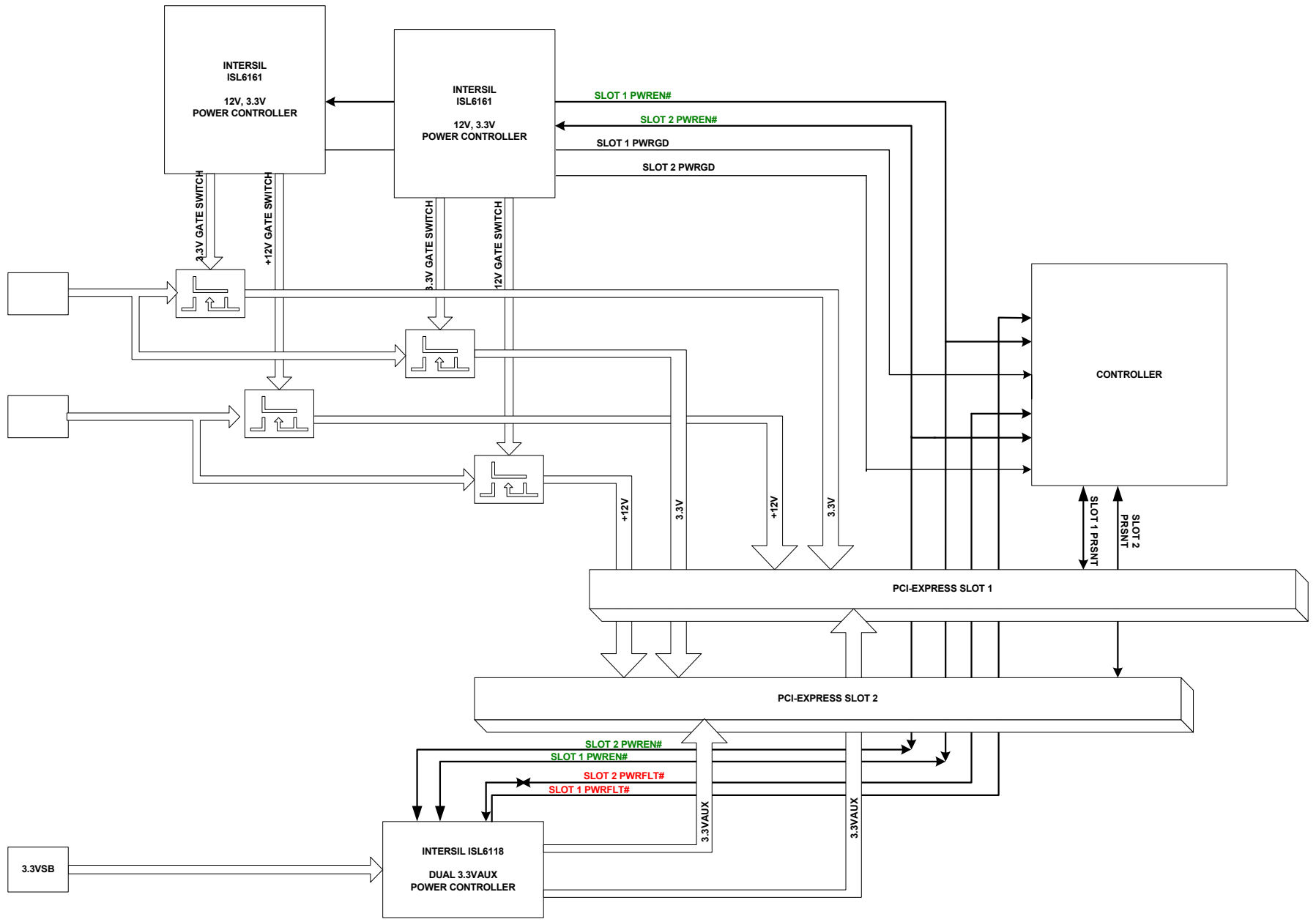

FIGURE 15. PCI EXPRESS IMPLEMENTATION OF THE ISL6161 AND ISL6118

Revision History The revision history provided is for informational purposes only and is believed to be accurate, but not warranted. Please visit our website to make sure you have the latest revision.

DATE	REVISION	CHANGE
Aug 16, 2018	FN9104.7	Updated Ordering information table by removing ISL6161VZA, adding tape and reel parts, adding tape and reel unit column, and updating Note 1. Updated Disclaimer.
Jan 23, 2018	FN9104.6	-Applied new Header/Footer. -Added Related Literature section to page 1. -Cleaned up simplified schematic on page 2. -Added ISL6161VZA Information throughout document. -Added MSL note (Note 3). -Clarified R _{ILIM} in Pin Descriptions table on page 4. -Fixed unit typo on page 9. -Added caption to figure on page 10. -Removed About Intersil verbiage. Updated Disclaimer.
December 3, 2015	FN9104.5	Added Rev History and About Intersil Verbiage. Updated Ordering Information on page 1. Updated POD M14.15 to most current version. Rev change is as follows: Added land pattern and moved dimensions from table onto drawing.

Package Outline Drawings

M16.173

16 LEAD THIN SHRINK SMALL OUTLINE PACKAGE (TSSOP)

Rev 2, 5/10

For the most recent package outline drawing, see [M16.173](#).

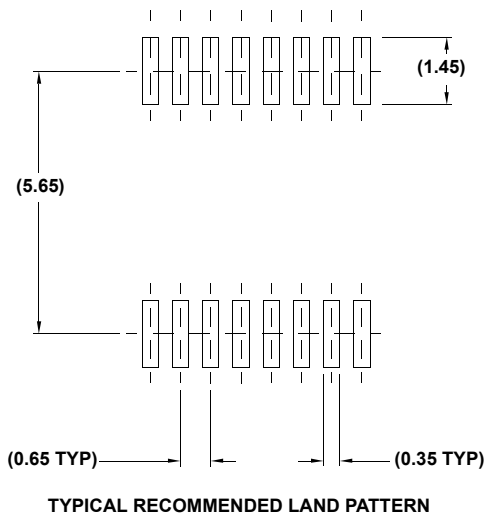
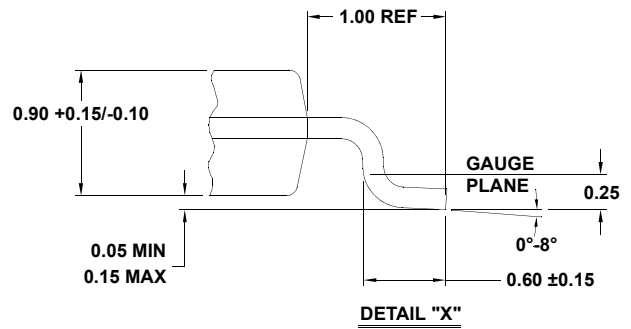
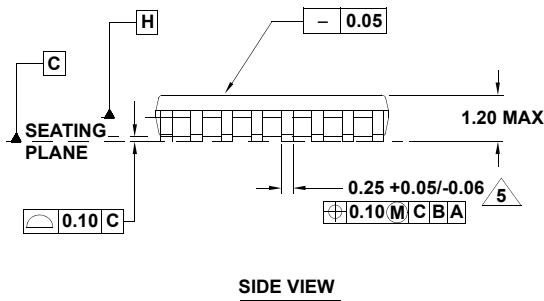
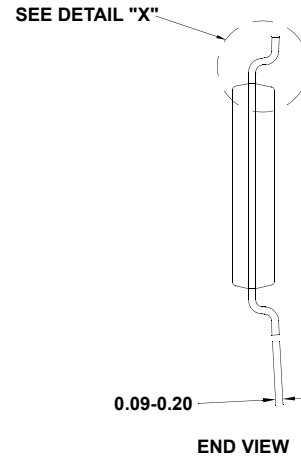
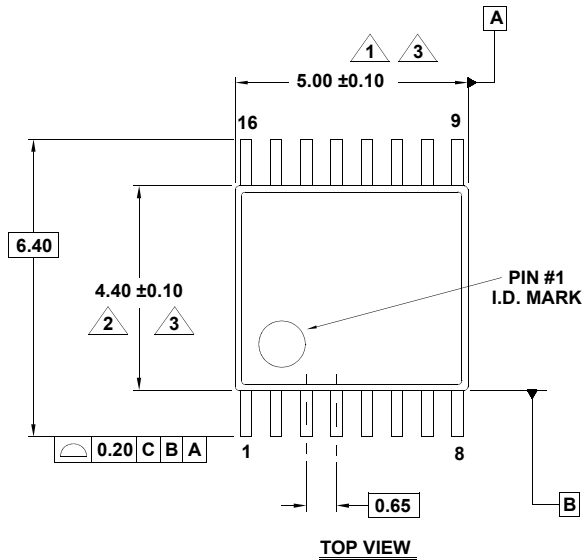

NOTES:

1. Dimension does not include mold flash, protrusions or gate burrs. Mold flash, protrusions or gate burrs shall not exceed 0.15 per side.
2. Dimension does not include interlead flash or protrusion. Interlead flash or protrusion shall not exceed 0.25 per side.
3. Dimensions are measured at datum plane H.
4. Dimensioning and tolerancing per ASME Y14.5M-1994.
5. Dimension does not include dambar protrusion. Allowable protrusion shall be 0.08mm total in excess of dimension at maximum material condition. Minimum space between protrusion and adjacent lead is 0.07mm.
6. Dimension in () are for reference only.
7. Conforms to JEDEC MO-153.

M14.15

14 LEAD NARROW BODY SMALL OUTLINE PLASTIC PACKAGE

Rev 1, 10/09

For the most recent package outline drawing, see [M14.15](#).

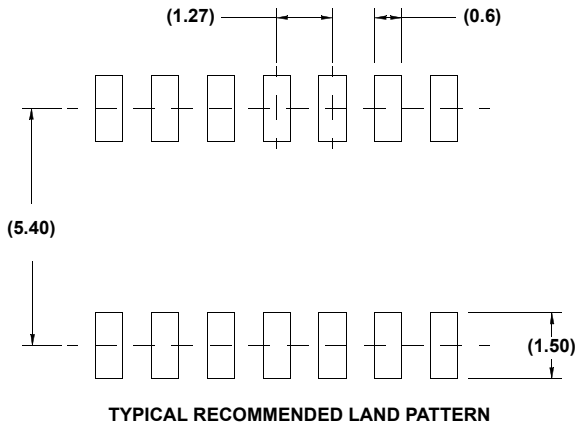
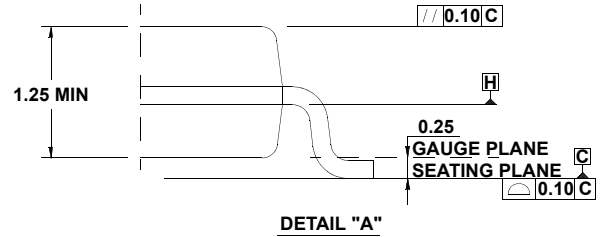
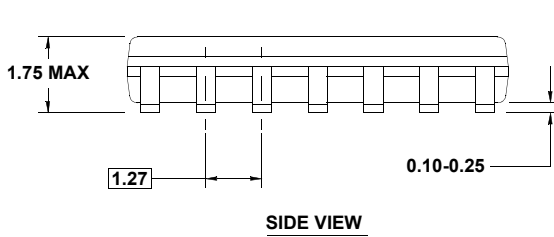
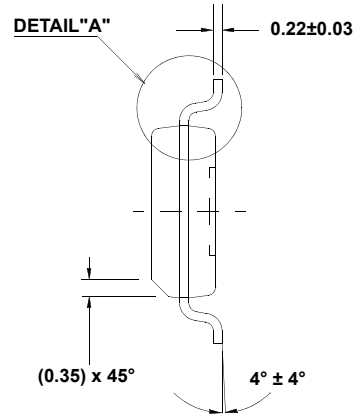
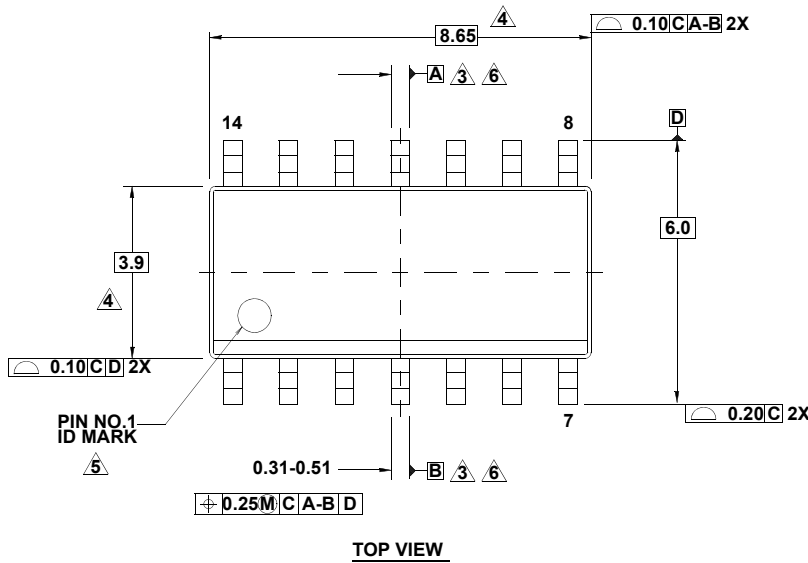

NOTES:

1. Dimensions are in millimeters.
Dimensions in () for Reference Only.
2. Dimensioning and tolerancing conform to AMSEY14.5m-1994.
3. Datums A and B to be determined at Datum H.
4. Dimension does not include interlead flash or protrusions.
Interlead flash or protrusions shall not exceed 0.25mm per side.
5. The pin #1 identifier may be either a mold or mark feature.
6. Does not include dambar protrusion. Allowable dambar protrusion shall be 0.10mm total in excess of lead width at maximum condition.
7. Reference to JEDEC MS-012-AB.

Notice

1. Descriptions of circuits, software and other related information in this document are provided only to illustrate the operation of semiconductor products and application examples. You are fully responsible for the incorporation or any other use of the circuits, software, and information in the design of your product or system. Renesas Electronics disclaims any and all liability for any losses and damages incurred by you or third parties arising from the use of these circuits, software, or information.
2. Renesas Electronics hereby expressly disclaims any warranties against and liability for infringement or any other claims involving patents, copyrights, or other intellectual property rights of third parties, by or arising from the use of Renesas Electronics products or technical information described in this document, including but not limited to, the product data, drawings, charts, programs, algorithms, and application examples.
3. No license, express, implied or otherwise, is granted hereby under any patents, copyrights or other intellectual property rights of Renesas Electronics or others.
4. You shall not alter, modify, copy, or reverse engineer any Renesas Electronics product, whether in whole or in part. Renesas Electronics disclaims any and all liability for any losses or damages incurred by you or third parties arising from such alteration, modification, copying or reverse engineering.
5. Renesas Electronics products are classified according to the following two quality grades: "Standard" and "High Quality". The intended applications for each Renesas Electronics product depends on the product's quality grade, as indicated below.
"Standard": Computers; office equipment; communications equipment; test and measurement equipment; audio and visual equipment; home electronic appliances; machine tools; personal electronic equipment; industrial robots; etc.
"High Quality": Transportation equipment (automobiles, trains, ships, etc.); traffic control (traffic lights); large-scale communication equipment; key financial terminal systems; safety control equipment; etc.
Unless expressly designated as a high reliability product or a product for harsh environments in a Renesas Electronics data sheet or other Renesas Electronics document, Renesas Electronics products are not intended or authorized for use in products or systems that may pose a direct threat to human life or bodily injury (artificial life support devices or systems; surgical implantations; etc.), or may cause serious property damage (space system; undersea repeaters; nuclear power control systems; aircraft control systems; key plant systems; military equipment; etc.). Renesas Electronics disclaims any and all liability for any damages or losses incurred by you or any third parties arising from the use of any Renesas Electronics product that is inconsistent with any Renesas Electronics data sheet, user's manual or other Renesas Electronics document.
6. When using Renesas Electronics products, refer to the latest product information (data sheets, user's manuals, application notes, "General Notes for Handling and Using Semiconductor Devices" in the reliability handbook, etc.), and ensure that usage conditions are within the ranges specified by Renesas Electronics with respect to maximum ratings, operating power supply voltage range, heat dissipation characteristics, installation, etc. Renesas Electronics disclaims any and all liability for any malfunctions, failure or accident arising out of the use of Renesas Electronics products outside of such specified ranges.
7. Although Renesas Electronics endeavors to improve the quality and reliability of Renesas Electronics products, semiconductor products have specific characteristics, such as the occurrence of failure at a certain rate and malfunctions under certain use conditions. Unless designated as a high reliability product or a product for harsh environments in a Renesas Electronics data sheet or other Renesas Electronics document, Renesas Electronics products are not subject to radiation resistance design. You are responsible for implementing safety measures to guard against the possibility of bodily injury, injury or damage caused by fire, and/or danger to the public in the event of a failure or malfunction of Renesas Electronics products, such as safety design for hardware and software, including but not limited to redundancy, fire control and malfunction prevention, appropriate treatment for aging degradation or any other appropriate measures. Because the evaluation of microcomputer software alone is very difficult and impractical, you are responsible for evaluating the safety of the final products or systems manufactured by you.
8. Please contact a Renesas Electronics sales office for details as to environmental matters such as the environmental compatibility of each Renesas Electronics product. You are responsible for carefully and sufficiently investigating applicable laws and regulations that regulate the inclusion or use of controlled substances, including without limitation, the EU RoHS Directive, and using Renesas Electronics products in compliance with all these applicable laws and regulations. Renesas Electronics disclaims any and all liability for damages or losses occurring as a result of your noncompliance with applicable laws and regulations.
9. Renesas Electronics products and technologies shall not be used for or incorporated into any products or systems whose manufacture, use, or sale is prohibited under any applicable domestic or foreign laws or regulations. You shall comply with any applicable export control laws and regulations promulgated and administered by the governments of any countries asserting jurisdiction over the parties or transactions.
10. It is the responsibility of the buyer or distributor of Renesas Electronics products, or any other party who distributes, disposes of, or otherwise sells or transfers the product to a third party, to notify such third party in advance of the contents and conditions set forth in this document.
11. This document shall not be reprinted, reproduced or duplicated in any form, in whole or in part, without prior written consent of Renesas Electronics.
12. Please contact a Renesas Electronics sales office if you have any questions regarding the information contained in this document or Renesas Electronics products.
(Note 1) "Renesas Electronics" as used in this document means Renesas Electronics Corporation and also includes its directly or indirectly controlled subsidiaries.
(Note 2) "Renesas Electronics product(s)" means any product developed or manufactured by or for Renesas Electronics.

(Rev.4.0-1 November 2017)



SALES OFFICES

Renesas Electronics Corporation

<http://www.renesas.com>

Refer to "<http://www.renesas.com/>" for the latest and detailed information.

California Eastern Laboratories, Inc.
4590 Patrick Henry Drive, Santa Clara, California 95054-1817, U.S.A.
Tel: +1-408-919-2500, Fax: +1-408-988-0279

Renesas Electronics Canada Limited
9251 Yonge Street, Suite 8309 Richmond Hill, Ontario Canada L4C 9T3
Tel: +1-905-237-2004

Renesas Electronics Europe Limited
Dukes Meadow, Millboard Road, Bourne End, Buckinghamshire, SL8 5FH, U.K
Tel: +44-1628-651-700

Renesas Electronics Europe GmbH
Arcadiastrasse 10, 40472 Düsseldorf, Germany
Tel: +49-211-6503-0, Fax: +49-211-6503-1327

Renesas Electronics (China) Co., Ltd.
Room 1709 Quantum Plaza, No.27 ZhichunLu, Haidian District, Beijing, 100191 P. R. China
Tel: +86-10-8235-1155, Fax: +86-10-8235-7679

Renesas Electronics (Shanghai) Co., Ltd.
Unit 301, Tower A, Central Towers, 555 Langao Road, Putuo District, Shanghai, 200333 P. R. China
Tel: +86-21-2226-0888, Fax: +86-21-2226-0999

Renesas Electronics Hong Kong Limited
Unit 1601-1611, 16/F., Tower 2, Grand Century Place, 193 Prince Edward Road West, Mongkok, Kowloon, Hong Kong
Tel: +852-2265-6688, Fax: +852 2886-9022

Renesas Electronics Taiwan Co., Ltd.
13F, No. 363, Fu Shing North Road, Taipei 10543, Taiwan
Tel: +886-2-8175-9600, Fax: +886 2-8175-9670

Renesas Electronics Singapore Pte. Ltd.
80 Bendemeer Road, Unit #06-02 Hyflux Innovation Centre, Singapore 339949
Tel: +65-6213-0200, Fax: +65-6213-0300

Renesas Electronics Malaysia Sdn.Bhd.
Unit 1207, Block B, Menara Amcorp, Amcorp Trade Centre, No. 18, Jln Persiaran Barat, 46050 Petaling Jaya, Selangor Darul Ehsan, Malaysia
Tel: +60-3-7955-9390, Fax: +60-3-7955-9510

Renesas Electronics India Pvt. Ltd.
No.77C, 100 Feet Road, HAL 2nd Stage, Indiranagar, Bangalore 560 038, India
Tel: +91-80-67208700, Fax: +91-80-67208777

Renesas Electronics Korea Co., Ltd.
17F, KAMCO Yangjae Tower, 262, Gangnam-daero, Gangnam-gu, Seoul, 06265 Korea
Tel: +82-2-558-3737, Fax: +82-2-558-5338

Mouser Electronics

Authorized Distributor

Click to View Pricing, Inventory, Delivery & Lifecycle Information:

[Renesas Electronics:](#)

[ISL6161CBZA](#) [ISL6161CBZA-T](#) [ISL6161IVZA-T](#)