

Specifications

Current Rating: 0.5A AC,DC(Per Pin)
 Voltage Rating: 50V AC,DC(Per Pin)
 Temperature Range: -25°C ~ +85°C
 Contact Resistance: 30mΩ Max.
 Insulation Resistance: 500MΩ Min.
 Withstanding Voltage: 500V AC/minute
 Contact H.R for Details

A
B
C
F

Standards



E179987

Ordering Code

① ② ③ ④
F1003 XX-X-XP

- ① Series No.
- ② Connector Type: WR=Right Angle,WV=Vertical
- ③ Mounting Type: S=SMT
- ④ No. of Circuits



F1003WV-S

1.00mm Pitch FFC/FPC 180° Connector, ZIF, SMT Type

Reference Information:

- *Material: Pin: Copper Alloy
- Solder Tabs: Copper Alloy
- Housing: Thermoplastic
- Actuator: Thermoplastic

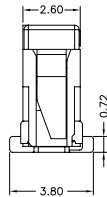
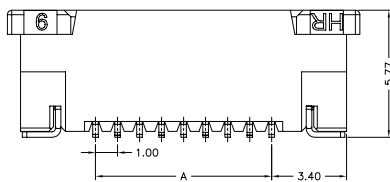
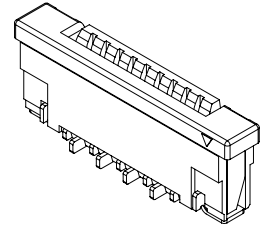
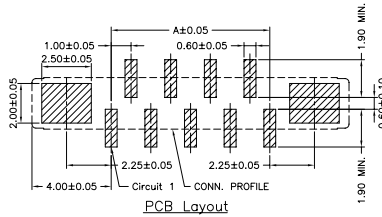
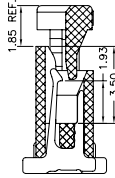
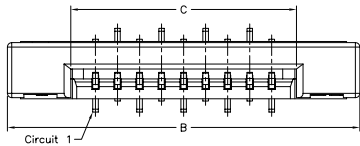

| | | | | | | | |
|--------------|---|---|---|----|---|----|---|
| F1003WV-S-XP | X | X | X | XX | X | XX | X |
| | ① | ② | ③ | ④ | ⑤ | ⑥ | ⑦ |

- ① Halogen Free or Not
- ② Material
- ③ Color
- ④ Plating Code for Contacts
- ⑤ Plating Code
- ⑥ Option Code
- ⑦ Packing Code

Dimensions:

| Circuit No. | Dimensions | | | Circuit No. | Dimensions | | |
|-------------|------------|-------|-------|-------------|------------|-------|-------|
| | A | B | C | | A | B | C |
| 04 | 3.00 | 11.00 | 5.10 | 20 | 19.00 | 27.00 | 21.10 |
| 05 | 4.00 | 12.00 | 6.10 | 21 | 20.00 | 28.00 | 22.10 |
| 06 | 5.00 | 13.00 | 7.10 | 22 | 21.00 | 29.00 | 23.10 |
| 07 | 6.00 | 14.00 | 8.10 | 23 | 22.00 | 30.00 | 24.10 |
| 08 | 7.00 | 15.00 | 9.10 | 24 | 23.00 | 31.00 | 25.10 |
| 09 | 8.00 | 16.00 | 10.10 | 25 | 24.00 | 32.00 | 26.10 |
| 10 | 9.00 | 17.00 | 11.10 | 26 | 25.00 | 33.00 | 27.10 |
| 11 | 10.00 | 18.00 | 12.10 | 27 | 26.00 | 34.00 | 28.10 |
| 12 | 11.00 | 19.00 | 13.10 | 28 | 27.00 | 35.00 | 29.10 |
| 13 | 12.00 | 20.00 | 14.10 | 29 | 28.00 | 36.00 | 30.10 |
| 14 | 13.00 | 21.00 | 15.10 | 30 | 29.00 | 37.00 | 31.10 |
| 15 | 14.00 | 22.00 | 16.10 | 31 | 30.00 | 38.00 | 32.10 |
| 16 | 15.00 | 23.00 | 17.10 | 32 | 31.00 | 39.00 | 33.10 |
| 17 | 16.00 | 24.00 | 18.10 | 33 | 32.00 | 40.00 | 34.10 |
| 18 | 17.00 | 25.00 | 19.10 | 34 | 33.00 | 41.00 | 35.10 |
| 19 | 18.00 | 26.00 | 20.10 | | | | |

Unit:mm

F1003WR-S

1.00mm Pitch FFC/FPC 90° Connector, ZIF, SMT Type, Top Contact Style

Reference Information:

- *Material: Pin: Copper Alloy
- Solder Tabs: Copper Alloy
- Housing: Thermoplastic
- Actuator: Thermoplastic

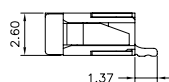
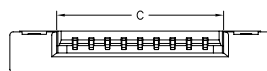
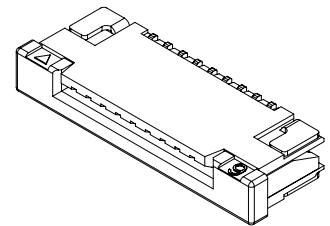
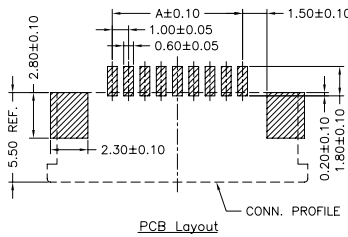
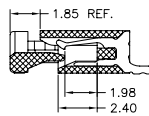
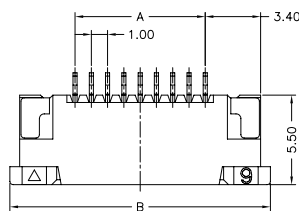

| | | | | | | | |
|--------------|---|---|---|----|---|----|---|
| F1003WR-S-XP | X | X | X | XX | X | T0 | X |
| | ① | ② | ③ | ④ | ⑤ | ⑥ | ⑦ |

- ① Halogen Free or Not
- ② Material
- ③ Color
- ④ Plating Code for Contacts
- ⑤ Plating Code
- ⑥ Option Code: T0=Top Contact Style
- ⑦ Packing Code

Dimensions:

| Circuit No. | Dimensions | | | Circuit No. | Dimensions | | |
|-------------|------------|-------|-------|-------------|------------|-------|-------|
| | A | B | C | | A | B | C |
| 04 | 3.00 | 11.00 | 5.10 | 20 | 19.00 | 27.00 | 21.10 |
| 05 | 4.00 | 12.00 | 6.10 | 21 | 20.00 | 28.00 | 22.10 |
| 06 | 5.00 | 13.00 | 7.10 | 22 | 21.00 | 29.00 | 23.10 |
| 07 | 6.00 | 14.00 | 8.10 | 23 | 22.00 | 30.00 | 24.10 |
| 08 | 7.00 | 15.00 | 9.10 | 24 | 23.00 | 31.00 | 25.10 |
| 09 | 8.00 | 16.00 | 10.10 | 25 | 24.00 | 32.00 | 26.10 |
| 10 | 9.00 | 17.00 | 11.10 | 26 | 25.00 | 33.00 | 27.10 |
| 11 | 10.00 | 18.00 | 12.10 | 27 | 26.00 | 34.00 | 28.10 |
| 12 | 11.00 | 19.00 | 13.10 | 28 | 27.00 | 35.00 | 29.10 |
| 13 | 12.00 | 20.00 | 14.10 | 29 | 28.00 | 36.00 | 30.10 |
| 14 | 13.00 | 21.00 | 15.10 | 30 | 29.00 | 37.00 | 31.10 |
| 15 | 14.00 | 22.00 | 16.10 | 31 | 30.00 | 38.00 | 32.10 |
| 16 | 15.00 | 23.00 | 17.10 | 32 | 31.00 | 39.00 | 33.10 |
| 17 | 16.00 | 24.00 | 18.10 | 33 | 32.00 | 40.00 | 34.10 |
| 18 | 17.00 | 25.00 | 19.10 | 34 | 33.00 | 41.00 | 35.10 |
| 19 | 18.00 | 26.00 | 20.10 | | | | |

Unit:mm



F1003WR-S

1.00mm Pitch FFC/FPC 90° Connector, ZIF, SMT Type, Bottom Contact Style

Reference Information:

- *Material: Pin: Copper Alloy
- Solder Tabs: Copper Alloy
- Housing: Thermoplastic
- Actuator: Thermoplastic

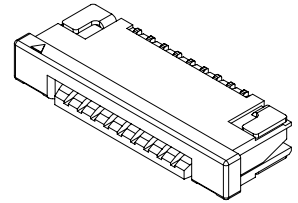
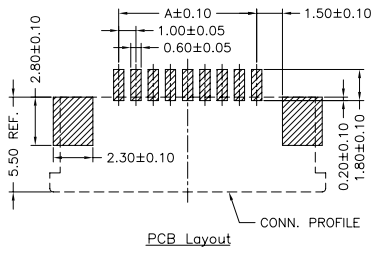
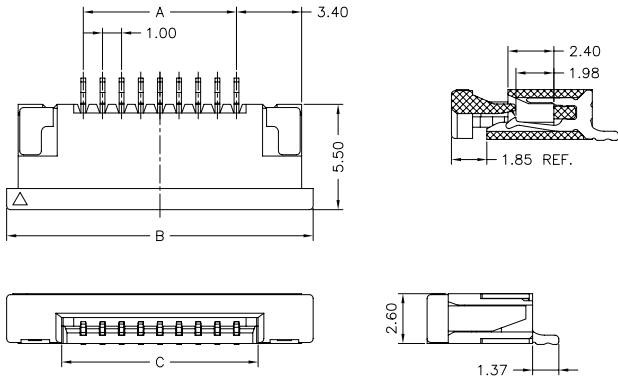

A
B
C
F

Dimensions:

| Circuit No. | Dimensions | | | Circuit No. | Dimensions | | |
|-------------|------------|-------|-------|-------------|------------|-------|-------|
| | A | B | C | | A | B | C |
| 04 | 3.00 | 11.00 | 5.10 | 20 | 19.00 | 27.00 | 21.10 |
| 05 | 4.00 | 12.00 | 6.10 | 21 | 20.00 | 28.00 | 22.10 |
| 06 | 5.00 | 13.00 | 7.10 | 22 | 21.00 | 29.00 | 23.10 |
| 07 | 6.00 | 14.00 | 8.10 | 23 | 22.00 | 30.00 | 24.10 |
| 08 | 7.00 | 15.00 | 9.10 | 24 | 23.00 | 31.00 | 25.10 |
| 09 | 8.00 | 16.00 | 10.10 | 25 | 24.00 | 32.00 | 26.10 |
| 10 | 9.00 | 17.00 | 11.10 | 26 | 25.00 | 33.00 | 27.10 |
| 11 | 10.00 | 18.00 | 12.10 | 27 | 26.00 | 34.00 | 28.10 |
| 12 | 11.00 | 19.00 | 13.10 | 28 | 27.00 | 35.00 | 29.10 |
| 13 | 12.00 | 20.00 | 14.10 | 29 | 28.00 | 36.00 | 30.10 |
| 14 | 13.00 | 21.00 | 15.10 | 30 | 29.00 | 37.00 | 31.10 |
| 15 | 14.00 | 22.00 | 16.10 | 31 | 30.00 | 38.00 | 32.10 |
| 16 | 15.00 | 23.00 | 17.10 | 32 | 31.00 | 39.00 | 33.10 |
| 17 | 16.00 | 24.00 | 18.10 | 33 | 32.00 | 40.00 | 34.10 |
| 18 | 17.00 | 25.00 | 19.10 | 34 | 33.00 | 41.00 | 35.10 |
| 19 | 18.00 | 26.00 | 20.10 | | | | |

Unit:mm

F1003WR-S-XP X X X XX X B0 X

① ② ③ ④ ⑤ ⑥ ⑦

- ① Halogen Free or Not
- ② Material
- ③ Color
- ④ Plating Code for Contacts
- ⑤ Plating Code
- ⑥ Option Code: B0=Bottom Contact Style
- ⑦ Packing Code