

Specifications

Current Rating: 4A~7A AC,DC(Per Pin)
 Voltage Rating: 250V AC,DC(Per Pin)
 Temperature Range: -25°C ~ +85°C
 Contact Resistance: 10mΩ Max.
 Insulation Resistance: 1000MΩ Min.
 Withstanding Voltage: 1500V AC/minute
 Contact H.R for Details

A
B
C
F

Standards



R 50004394

Assembly Layout

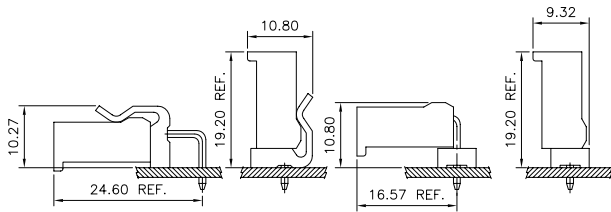

A3962H

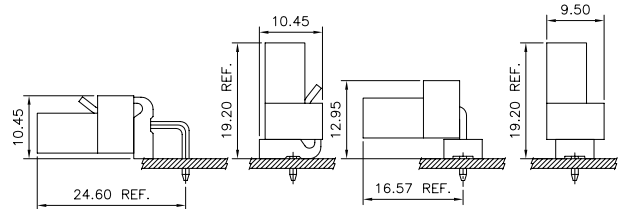

A3962HA

Ordering Code

① ② ③ ④
A3962-X X X

- ① Series No.
- ② Plating Code: T=Tin-Plated
- ③ Material: B=Brass
- ④ E=Stamping Before Plating

① ② ③ ④
A3962 X X-XP

- ① Series No.
- ② Housing Type:H=Housing
- ③ Blank=Normal Type, A=A Type
- ④ No. of Circuits



A3962 SERIES

3.96mm Pitch Wire to Board Connector

A3962-XXX

3.96mm Pitch Crimp Terminal

Reference Information:

*Used in H.R A3962 Series Housing

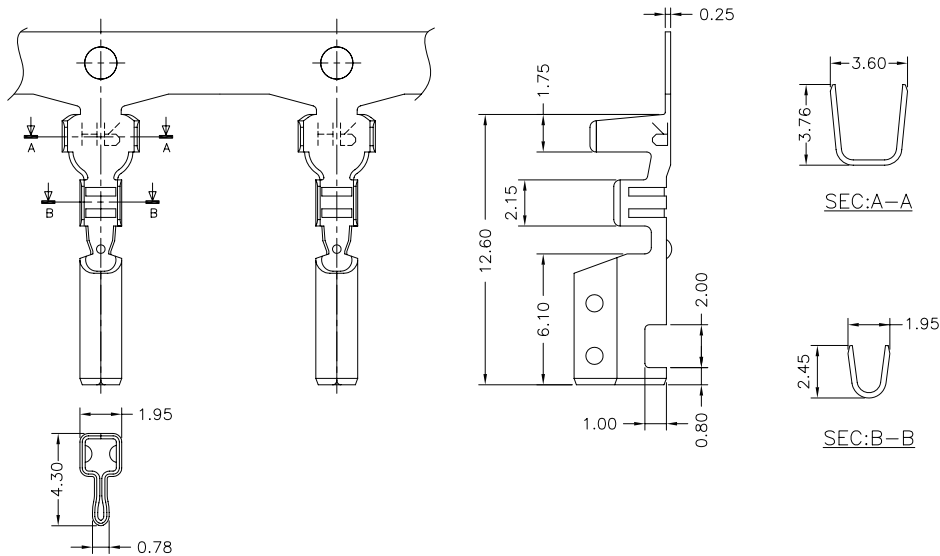

A
B
C
F

Ordering Information & Specifications:

Unit:mm

Part No.	Wire Range	Insulation O.D.	Material	Finish	Qty/Reel
A3962-TBE	AWG#18-#24	3.20mm(Max)	Brass	Tin-Plated	5,000Pcs

Note:E-Stamping Before Plating

A3962H

3.96mm Pitch Housing

Reference Information:

*Material: Thermoplastic

*Suitable H.R A3962 Series Terminal

*Mates with H.R A3960 or A7920 Series Wafer

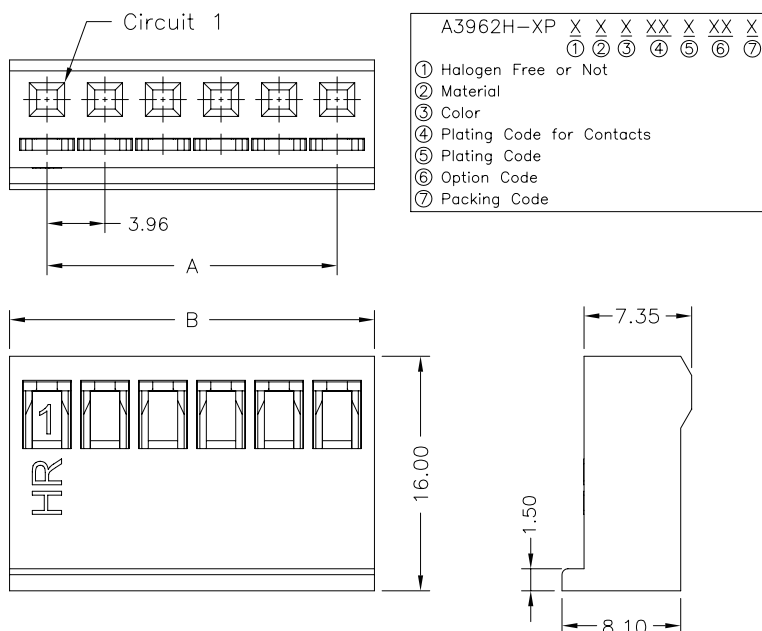
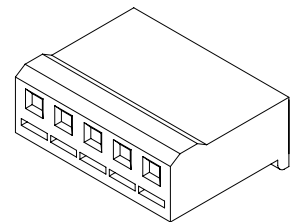

Dimensions:

Circuit No.	Dimensions	
	A	B
02	3.96	9.06
03	7.92	13.02
04	11.88	16.98
05	15.84	20.94
06	19.80	24.90
07	23.76	28.86
08	27.72	32.82
09	31.68	36.78
10	35.64	40.74
11	39.60	44.70
12	43.56	48.66

Unit:mm



A3962HA

— 3.96mm Pitch Housing —

Reference Information:

- *Material: Thermoplastic
- *Suitable H.R A3962 Series Terminal
- *Mates with H.R A3960 or A7920 Series Wafer

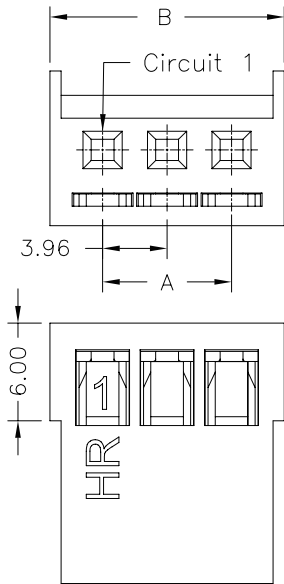
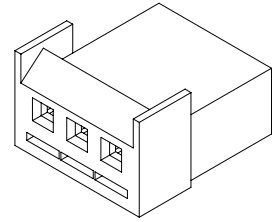

A3962HA-XP							
	X	X	X	XX	X	XX	X
①	②	③	④	⑤	⑥	⑦	
①	Halogen Free or Not						
②	Material						
③	Color						
④	Plating Code for Contacts						
⑤	Plating Code						
⑥	Option Code						
⑦	Packing Code						

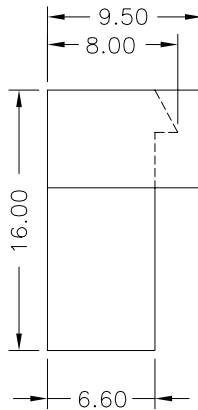

Dimensions:

Circuit No.	Dimensions	
	A	B
02	3.96	10.43
03	7.92	14.39
04	11.88	18.35
05	15.84	22.31
06	19.80	26.27
07	23.76	30.23
08	27.72	34.19
09	31.68	38.15
10	35.64	42.11
11	39.60	46.07
12	43.56	50.03

Unit:mm

A
B
C
F